

Systems

**IBM 3741
Data Station
Reference Manual**

IBM

Fifth Edition (November 1977)

This is a major revision of, and obsoletes, GA21-9183-3. Changes are indicated by a vertical line at the left of the change; new or extensively revised illustrations are denoted by a bullet (●) at the left of the figure caption.

Changes are periodically made to the information in this manual and will be reported in subsequent revisions or technical newsletters.

Requests for copies of IBM publications should be made to your IBM representative or to the IBM branch office serving your locality.

A Reader's Comment Form is at the back of this publication. If the form has been removed, address your comments to IBM Corporation, Publications, Department 245, Rochester, Minnesota 55901. Comments become the property of IBM.

This publication is a reference manual that provides specific information about the IBM 3741 Data Station. This publication is intended for installation supervisors, application personnel, system analysts, and system engineers who wish specific information on the programming for and operational considerations of the IBM 3741 Data Station.

The IBM 3741 Data Station is part of the IBM 3740 Data Entry System. The 3741 Data Station consists of two models (Models 1 and 2). The only difference between Model 1 and Model 2 is the addition of binary synchronous communications capabilities on Model 2.

Like the 3741 Data Station, the IBM 3741 Programmable Work Station is part of the IBM 3740 Data Entry System. The 3741 Programmable Work Station consists of two models (Models 3 and 4). The 3741 Programmable Work Station functions as a 3741 Data Station unless the 3741 Programmable Work Station is under control of an ACL program. This publication provides information about the 3741 Programmable Work Station only when it functions as a 3741 Data Station.

In this publication, references made to the 3741 Data Station Models 1 or 2 apply (respectively) to the 3741 Programmable Work Station Model 3 or 4 (when Models 3 and 4 are not under control of an ACL program). For information about the 3741 Programmable Work Station when it is under control of an ACL program, see *IBM 3741 Models 3 and 4 Programmable Work Station General Information*, GA21-9196, or *IBM 3741 Models 3 and 4 Programmable Work Station Programming Reference Manual*, GA21-9194.

This publication is divided into the following chapters and appendixes:

- *Chapter 1. IBM 3741 Data Station* provides an overview of the 3741.
- *Chapter 2. Operation Modes and Considerations* provides information about buffers, modes of operation, and related considerations concerning the 3741.
- *Chapter 3. Program Information* provides information on program coding, program chaining, and operator guidance.
- *Chapter 4. Production Statistics* provides information on the production statistic counters, and the displaying of the counters.
- *Chapter 5. Online Field Totals* and *Chapter 6. Offline Field Totals* provide information on online and offline field totals capabilities.
- *Chapter 7. Second Disk* provides information on second disk search, and copy operations when the second disk is added to the 3741.
- *Chapter 8. Disk Initialization* provides information on how to initialize or check a diskette.
- *Chapter 9. Self-Check Feature* provides information about self-checking when using modulus 10 or modulus 11.
- *Chapter 10. Communications* provides information on the binary synchronous communications feature of the 3741.
- *Chapter 11. IBM 3713, IBM 3715, and IBM 3717 Printers* provides information on how the 3713, 3715, and 3717 Printers are used when attached to the 3741.
- *Chapter 12. Proof Keyboard Feature* provides information about the numeric key rearrangement for the proof keyboard.
- *Chapter 13. Data Recorder Attachment Feature* provides information on how the 129 Card Data Recorder and 5496 Data Recorder are used when attached to a 3741.
- *Chapter 14. I/O Adapter* provides information on how the 3741 can transfer data directly to or from a system.
- *Appendix A. Timings* provides information on timing for searches, offline field totals, copies, and disk initialization operations.
- *Appendix B. Card Punch to Hexadecimal Conversion.*

This publication assumes that the reader is familiar with data entry techniques and is also familiar with the contents of the following manuals:

- *IBM 3740 Data Entry System System Summary and Installation Planning*, GA21-9152.
- *IBM 3741 Data Station Operator's Guide*, GA21-9131.
- *The IBM Diskette General Information Manual*, GA21-9182.
- *IBM 3742 Dual Data Station Reference Manual*, GA21-9184.

CHAPTER 1. IBM 3741 DATA STATION	1	CHAPTER 4. PRODUCTION STATISTICS	34
IBM 3741 Data Station Overview	1	Counters	34
Keyboard	2	Keystroke Counter	34
Display	2	Record Counter	34
Diskette Unit	3	Verify Correction Keystroke Counter	34
Standard Functions and Available Features	4	Displaying Production Statistics	34
		Track to Record Conversion Table	35
CHAPTER 2. OPERATION MODES AND CONSIDERATIONS	5	CHAPTER 5. ONLINE FIELD TOTALS	36
Buffers	5	Online Field Totals Operation	36
Current Record Buffer	5	Displaying Field Totals	36
Previous Record Buffer	5	Programming Online Field Total Fields	36
Hold Buffer	5	Accumulate Totals Fields	37
Program Buffers	5	Read Out/Reset Field Total Fields	37
Power On Information	5	Online Field Total Restrictions	38
Modes of Operation	6	Example	38
Read Index Mode (X)	6	Auto Balance Example	39
Index Track Data Set Labels	8	CHAPTER 6. OFFLINE FIELD TOTALS	40
Data Set Label Error Checking	11	Offline Field Totals Operation	40
Modify Index Mode (M)	11	Displaying Offline Field Total Accumulators	40
Enter Mode (E)	12	Programming Offline Field Total Fields	41
Update Mode (U)	13	Accumulate Totals Fields	41
Verify Mode (V)	13	Read Out Field Totals Fields	41
Field Correct Mode (C)	15	Read Out/Reset Field Totals Fields	41
Search Mode (S)	15	Control Statements	42
Field Totals Mode (F)	18	Control Statement Format Character Description	43
Hexadecimal Data	18	Examples	45
Multipunch Operations	19	Unconditional Program Buffer Selection	46
Hexadecimal Display	19	Offline Field Totals Example	46
Deleted Records	19	Program Buffer 5	47
Mode Considerations for Deleted Records	20	Program Buffer 6	47
Record Insert Feature	20	Program Buffer 7	47
Record Insert Mode Characteristics	21	Offline Field Totals Setup Example	47
Adding Records to a Batch	22	CHAPTER 7. SECOND DISK	49
Data Recovery	22	Dual Disk Operation on the 3741	49
Bad Spots on Disk	23	Search Operations on the Second Disk	49
No Record Found (2) Error	23	Copy	50
Seek (3) Error	23	Copy All (Image Copy) or Part of Disk 2	50
Disk Read (4) Error	23	Copy All (Image Copy) or Part of a Data Set	50
Disk Write (5) Error	24	Copy Up to a Specified Record on Disk 2	50
CE Mode	24	Copying a Record	50
CHAPTER 3. PROGRAM INFORMATION	25	CHAPTER 8. DISK INITIALIZATION	51
Program Coding	25	Initialization Procedure	52
Program Field Descriptions	25	Disk Checking	53
Creating and Storing Programs	28	CHAPTER 9. SELF-CHECK FEATURE	55
Displaying Programs	30	Computing the Self-Check Digit	55
Changing a Program in a Program Buffer	30	Modulus 10	55
Program Chaining	30	Modulus 11	56
Program Chaining Example	31		
Operator Guidance	31		
Prompting Messages	32		

CHAPTER 10. COMMUNICATIONS	57
Networks	59
Features	61
Synchronous Clock	61
Terminal Identification	61
Operator Identification Card Reader	62
Keylock	62
Expanded Communications Feature	63
Expanded Communications/Multipoint Data Link Control Feature	66
Programming Support	68
Communication Modes	68
Transmit Mode (T)	69
Expanded Communications Transmit Mode (J)	69
Transmit-Transparent Mode (P)	70
Transmit Mode Examples	71
Receive Mode (R)/Expanded Communications Receive	72
Receive Mode Example	74
Transmit/Receive Mode (B)	74
Expanded Communications Transmit/Receive Mode (K)	76
Transmit-Transparent/Receive Mode (D)	76
Writing of Received Data Over Previously Transmitted Data	76
Transmit/Receive Mode Examples	77
Inquiry Mode (I)	80
Binary Synchronous Communications Summary	81
Operating Procedures	82
Line Termination and Error Conditions	89
Termination of the Data Call	89
Inquiry Mode Termination	89
BSCA Error Conditions and Indications	89
BSCA Disk Errors	90
Track and Sector Indicators	91
Status Message Format	92
BSC CE Status Line	92
Error Recovery Procedures	92
COMMUNICATIONS THROUGHPUT	94
CHAPTER 11. IBM 3713, IBM 3715, AND IBM 3717 PRINTERS	95
IBM 3713 Printer	95
IBM 3713 Adjustable Margins Feature	95
IBM 3713 Forms Stand Feature	95
IBM 3715 Printer	96
IBM 3715 Forms Stand Feature	96
IBM 3717 Printer	97
IBM 3717 Forms Stand Feature	97
Functions	97
Printer Modes	97
Printer Formatting	98
Local Format Control	99
Horizontal Tab and Vertical Skip Stop Characters	102
Local Format Control Example	104
Processing Unit Format Control	107
Printer Error Conditions	110
U Error (Printer)	110
W Error (Printer Format)	110
Editing on the 3715 and 3717	111
Editing Consideration	111
Editing Example	114

CHAPTER 12. PROOF KEYBOARD FEATURE	116
CHAPTER 13. DATA RECORDER ATTACHMENT FEATURE	117
Punch Operations	117
Punch Modes	117
Read Operations	118
Read Modes	118
Format Current Record Buffer	119
Card Read/Punch Format Control	120
Program Level A	120
Card Read/Punch Format Control Programs	121
Card Read/Punch Format Instruction Set	121
Function Switches	122
How Format Control Works	123
Format Control Examples	124
CHAPTER 14. I/O ADAPTER	130
File Transfer	130
Mode 1	131
Mode 2	131
Mode 3	131
Mode 4	132
Mode 5	132
Summary of File Transfer Operations (Read or Write)	133
Error Recovery Procedures	134
Disk Errors	134
System Channel Errors	134
APPENDIX A. TIMINGS	135
APPENDIX B. CARD PUNCH TO HEXADECIMAL CONVERSION	136
CARD PUNCH TO HEX CONVERSION (IN HEXADECIMAL ORDER)	136
CARD PUNCH TO HEX CONVERSION (IN CARD PUNCH ORDER)	137
GLOSSARY	138
INDEX	140

IBM 3741 DATA STATION OVERVIEW

The IBM 3741 Data Station is part of the 3740 Data Entry System. The IBM 3741 Data Station is a key entry device used to record data on a data recording medium called the IBM diskette.

Model 1 (Figure 1) is a standalone device which has one keyboard unit, one display unit, one or two diskette units, and a control unit. Model 2 (not pictured) is the same as Model 1, with the addition of a binary synchronous communications adapter.

Once data has been recorded on the diskette by the 3741, the data can be transmitted to another location through the use of binary synchronous communications. For Model 2 only, or for Models 1 and 2, the data can be:

- Converted to tape by using the IBM 3747 Data Converter

- Processed by the 3741 Programmable Work Station Models 3 or 4
- Used with the IBM 3540 Diskette Input/Output Unit which provides direct input capabilities to a System/370
- Printed by the 3713, 3715, or the 3717 Printer

Note: The 3741 Programmable Work Station, Models 3 and 4, operates as a 3741 Data Station, unless the Programmable Work Station is under Application Control Language (ACL) program control. When operating as a Data Station, the Model 3 has the same functions and available features as the Model 1; and the Model 4 has the same functions and available features as the Model 2. See *IBM 3741 Models 3 and 4 Programmable Work Station Programming Reference Manual, GA21-9194*, for information on the 3741 Programmable Work Station, under ACL program control.

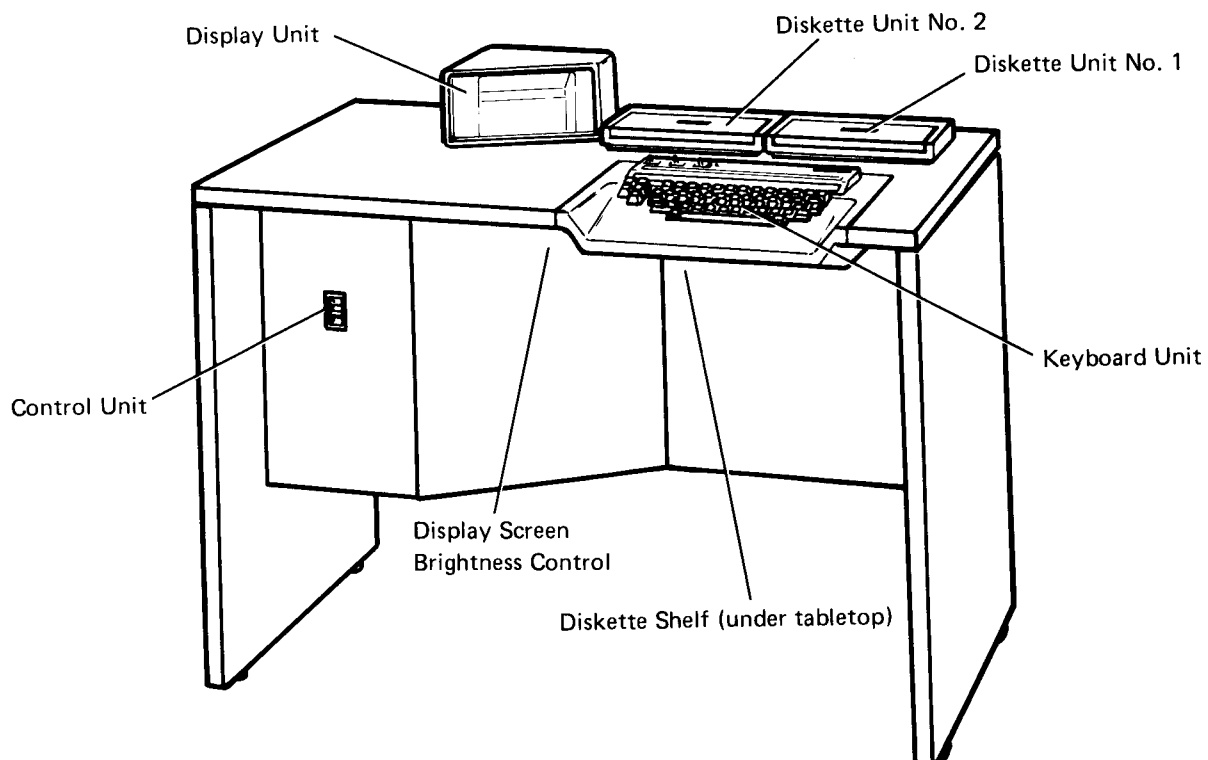

Figure 1. IBM 3741 Data Station

Keyboard

The keyboard (Figure 2) consists of data keys, special function keys, function select keys, two rows of labels, and switches. Data keys provide the means of keying 64 different displayable characters. All 256 EBCDIC codes can be keyed with the use of the HEX key. The function select keys are used to redefine the top row of keys as indicated by the two rows of labels above the top row of keys. The lefthand function select key, lettered in green, is associated with the upper row of labels (that

is, redefines the top row of keys according to the top row of labels), which are also green. The righthand function select key, lettered in white, is associated with the lower row of labels. The special keys (DUP, FIELD BKSP, REC ADV, RESET, etc.) perform specific functions during data entry. The switches provide automatic skip/duplicate, automatic record advance, and program numeric shift functions. For a complete description of the keyboard's keys and switches, see the *IBM 3741 Data Station Operator's Guide*, GA21-9131.



Figure 2. 3741 Keyboard (Model 1)

Display

The display (Figure 3) provides station status information, program information, and data on the screen. The 3741 Data Station uses six 40-character lines of the display screen. Line 1 indicates station status. Lines 2, 3, 4, and the first eight positions (total of 128 positions) of line 5 display either data or program information, depending upon the display mode selected. The last 30 positions of line 5 and 6 are used for the operator guidance feature. A cursor (underscore) is used to indicate the position of the next character to be entered.

A complete description of the display is provided in the *IBM 3741 Data Station Operator's Guide*, GA21-9131.

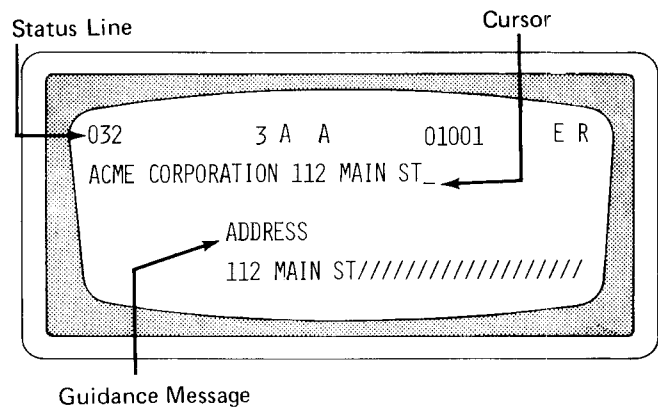

Figure 3. Display Unit with Operator Guidance

Diskette Unit

The disk unit reads and writes on one side of the diskette. Figure 4 shows the IBM diskette. For a complete description of the IBM diskette, its layout, care, storage, and handling, see *The IBM Diskette General Information Manual*, GA21-9182.

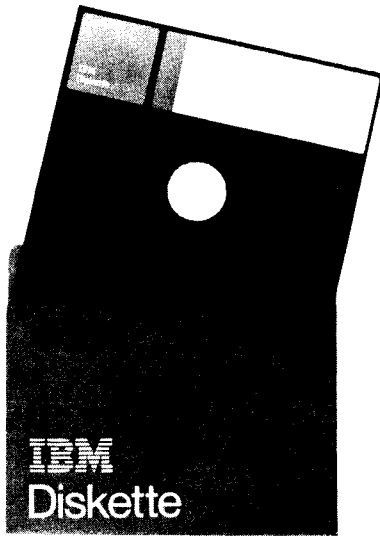

Figure 4. IBM Diskette

STANDARD FUNCTIONS AND AVAILABLE FEATURES

Figure 5 shows the standard functions and available features for the 3741.

Standard Function or Feature	IBM 3741 Data Station (Models 1 and 2) and IBM 3741 Programmable Work Station* (Models 3 and 4)
Communications	Standard on the 3741 Model 2 or 4; not available on Model 1 or 3
Expanded communications	Feature on Model 2 or 4
Entering and updating records	Standard
Operator guidance	Standard
Program chaining	Standard
Record length of 1 to 128 characters	Standard
Search on content	Standard
Search on end of data	Standard
Search on record address	Standard
Search on sequential content	Standard
Ten levels of program control	Standard
Data recorder attachment	Feature
Disk copy	Standard on second disk
Keylock	Feature on Model 2 or 4
Operator identification card reader	Feature on Model 2 or 4
Proof keyboard	Feature
Record insert	Feature

*Not under ACL program control.

Figure 5 (Part 1 of 2). Standard Functions and Available Features

Standard Function or Feature	IBM 3741 Data Station (Models 1 and 2) and IBM 3741 Programmable Work Station* (Models 3 and 4)
Second disk	Feature
Synchronous clock	Feature on Model 2 or 4
Terminal identification	Feature on Model 2 or 4
1200 bps integrated modem	
Nonswitched	Feature
Switched with auto answer	Feature
3713 Printer	Feature
3715 Printer	Feature
3717 Printer	Feature
Feature group A:	Feature
Disk initialization	
Offline field totals	
Online field totals	
Production statistics	
Self-check number (modulus 10 and modulus 11)	
Verify	

*Not under ACL program control

Figure 5 (Part 2 of 2). Standard Functions and Available Features

Entering, updating, verifying or searching of data on a disk is performed by the data stations using different modes of operation. The sequence of operations performed by the control unit within the data station is directly dependent upon the mode in which the station is operating. Each mode of operation is unique, and, therefore, the use of buffers, keys, and information displayed is different in each mode.

BUFFERS

Buffers are temporary storage areas used for transferring data between the keyboard, display, and disk. The buffers are the current record buffer, previous record buffer, hold buffer, and program buffers.

Current Record Buffer

The current record buffer receives data characters as they are keyed. Records read from disk are also placed in this buffer. Data displayed on the display screen is from the current record buffer.

Previous Record Buffer

The previous record buffer contains the record that was previously displayed in the current record buffer. Data is written on the disk from this buffer. The previous record buffer is the buffer from which characters are obtained by the control unit for duplicating into duplicate fields in the current record buffer.

Hold Buffer

The hold buffer contains the next record to be verified when in verify mode. This buffer contains the search mask during search on content or search on sequential content operations.

Program Buffers

The 3741 has 10 program buffers numbered 1 through 9 and A. The program buffers usually contain programs that control record format and processing. For offline field totals operations, the program buffers will also contain some field totals control statements that are required in order to perform the field totals operations. See *Chapter 6. Offline Field Totals* for more information. Program buffers are also used to contain operator guidance prompting message records. For information on operator guidance, see *Operator Guidance* in *Chapter 3. Program Information*.

POWER ON INFORMATION

When the 3741 is turned on, the current record, previous record, and hold buffers are filled with blanks, and the program buffers are filled with N's. Program buffer 0 is selected. The status line displays the machine-not-ready disk status (N), the read index mode (X), program level 0, and current disk address 00000. All other positions on the status line are blank.

Closing the cover on the diskette that has been inserted changes the machine status to wait (W). The volume label is read but not displayed, and the accessibility field in the volume label is checked. The accessibility field is used to allow (field is blank) or inhibit (field contains any character) use of a disk. If the accessibility field is not blank, the disk cannot be processed and an A error is displayed. Then the 3741 waits for the diskette to be removed.

A write test is made; if not successful, ?? is displayed in positions 9 and 10 of the status line. If ?? is displayed, other disks should be inserted to see if the ?? disappears. If the ?? continues to be displayed, call IBM for service since the machine cannot write records on disk.

If all tests are successful, sector 08 is read and displayed. Sector 08 contains the first data set label (a data set label defines required information about a data set. See *Index Track Data Set Labels* in this chapter for more information). Data entry or other data station operations can now be performed.

MODES OF OPERATION

The mode of operation is indicated by a code displayed in position 38 of the status line of the display unit. Some of the modes of operation for the 3741 and their corresponding display codes are:

Mode	Display Code
Read index	X
Modify index	M
Enter	E
Update	U
Verify	V
Field correct	C
Search	S
Field totals	F

Read Index Mode (X)

The 3741 is in read index mode whenever it is on the index track. The read index mode allows records on the index track representing the volume label, the data set labels, and other system data to be displayed on the display screen. These records can also be modified or deleted by a special procedure called modify index. See *Modify Index Mode (M)* in this section for further information. Figure 6 shows the data flow for read index mode.

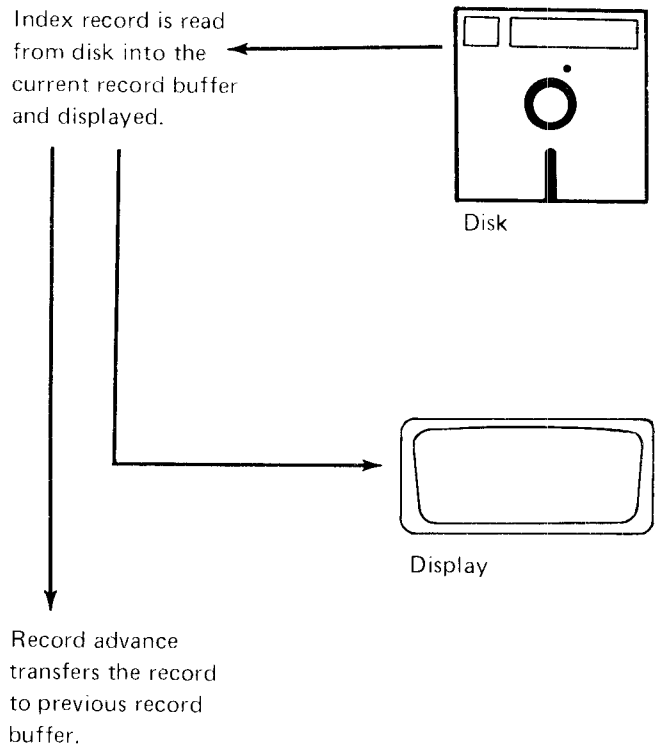

Figure 6. Data Flow for Read Index Mode

Index Track Layout

The first track on a disk is called the index track and is numbered 00. The index track's 26 sectors are for system or data set label information. The 26 sectors on each of the remaining tracks, numbered 01 through 73, are used for data. Each sector can contain one record. Track 74 is reserved and should not be used for data entry.

The first seven sectors of the index track may contain system information or information about the diskette, such as the location of tracks that have developed errors in use. These seven sectors are not usually used or modified by the operator. The remaining sectors (08-26) may contain data set labels, which are used to define the data sets resident on the disk.

Each record on the index track has a record length of 80 characters. The index track layout is shown in Figure 7.

Sector	Contents																																						
Sector 1	80 blanks																																						
Sector 2	80 blanks																																						
Sector 3	Position 1: machine test character for a write test																																						
Sector 4	80 blanks																																						
Sector 5	Positions 1-5: ERMAMP; positions 6-80: blanks If the disk has 1 or 2 bad tracks, positions 7 and 8 indicate the first bad track and position 9 contains a 0; positions 11 and 12 indicate the second bad track and position 13 contains a 0.																																						
Sector 6	80 blanks																																						
Sector 7	Volume label: positions <div style="text-align: center;"> <table style="margin: auto; border-collapse: collapse;"> <tr> <td style="padding: 0 5px;">1</td><td style="padding: 0 5px;">2</td><td style="padding: 0 5px;">3</td><td style="padding: 0 5px;">4</td><td style="padding: 0 5px;">5</td><td style="padding: 0 5px;">6</td><td style="padding: 0 5px;">7</td><td style="padding: 0 5px;">8</td><td style="padding: 0 5px;">9</td><td style="padding: 0 5px;">10</td><td style="padding: 0 5px;">11</td><td style="padding: 0 5px;">12</td><td style="padding: 0 5px;">...</td><td style="padding: 0 5px;">76</td><td style="padding: 0 5px;">77</td><td style="padding: 0 5px;">78</td><td style="padding: 0 5px;">79</td><td style="padding: 0 5px;">80</td> </tr> <tr> <td style="padding: 0 5px;">V</td><td style="padding: 0 5px;">O</td><td style="padding: 0 5px;">L</td><td style="padding: 0 5px;">1</td><td colspan="8"></td><td style="padding: 0 5px;">b</td><td colspan="4"></td><td style="padding: 0 5px;">b</td><td style="padding: 0 5px;">b</td><td style="padding: 0 5px;">W</td> </tr> </table> <p style="text-align: center; margin-top: 10px;"> Volume ID* ↑ 12 through 76 contains blanks ↑ Sector sequence information </p> <p style="text-align: center; margin-top: 10px;"> Accessibility – Any non-blank character means disk is not accessible </p> </div>	1	2	3	4	5	6	7	8	9	10	11	12	...	76	77	78	79	80	V	O	L	1									b					b	b	W
1	2	3	4	5	6	7	8	9	10	11	12	...	76	77	78	79	80																						
V	O	L	1									b					b	b	W																				
Sectors 8-26	Data set labels																																						

*The volume ID field contains IBMIRD when the diskette is received from IBM. When you initialize the diskette, the volume ID field contains either the volume ID entered by the operator or is blank if the operator did not enter a volume ID.

Figure 7. Index Track Layout

Index Track Data Set Labels

Sectors 8 through 26 of the index track are used primarily for data set labels. A data set label defines required information about a data set on disk such as beginning of extent (BOE), end of data (EOD), end of extent (EOE), and the record length of records for the data set.

Data Set Label Field Description

Figure 8 shows the field layout of a data set label. The following is a description of each of the fields in the data set label.

Header 1 Field (Positions 1-4): The header 1 field, a required field, is a data set label identifier for system application. It must be HDR1 in order to be a valid data set label identifier. When a disk is initialized, only sector 8 of the index track has HDR1. Sectors 9-26 contain DDR1 in positions 1 through 4 and are deleted. The deleted label identifier can be modified to a valid data set label identifier (HDR1) by using the modify index mode. Modifying the label in this way allows you to define more data sets on one disk.

Data Set Name Field (Positions 6-13): The data set name field, an optional field, is provided to allow you to give the data set a descriptive name. When a disk is initialized, the data set name field of the data set label in sector 08 contains DATA as a name. The data set name field of the data set labels in sectors 09 through 26 contains DATA 09 through DATA 26, respectively. The data set name can be changed to a descriptive data set name by using the modify index mode.

Record Length Field (Positions 23-27): The record length field, a required field, must contain the logical record length for the records to be placed in the data set. Disk initialization places the record length into this field for you. For the 3741, the record length field can be 00001 through 00128. Disk initialization can be used to set the record length to 128. The modify index mode can be used to change the 128 to any value from 1 through 128.

Beginning of Extent Field (Positions 29-33): The beginning of extent (BOE) field, a required field, identifies the address of the first sector of the data set (where the first record of the data set will be). The BOE field has this format: TT0SS where TT is the track number and SS is the sector number. The track number must be in positions 29 and 30, a 0 must always be in position 31, and the sector number must be in positions 32 and 33. The BOE address must be 01001 or greater.

End of Extent Field (Positions 35-39): The end of extent (EOE) field, a required field, identifies the address of the last sector of the data set (where the last record of the data set will be). The EOE field has the same format as the BOE field. The track number (TT) must be in positions 35 and 36, a 0 must always be in position 37, and the sector number (SS) must always be in positions 38 and 39. The EOE address cannot be larger than 74026 or an incorrect data set label (B) error will occur. However, track 74 is reserved and should not be used for data entry.

Bypass Data Set Field (Position 41): The bypass data set field is a field for use by the 3747 or the 3741 with the communications feature, data recorder attachment feature, and I/O adapter. This field must contain a B or be blank. If the field contains a B, the 3747 bypasses the data set (the data in the data set is not converted to tape). If the field is blank, the data in the data set is converted to tape. This field allows you to store programs and data on the same disk. A B would be put into the bypass data set field of the data set label describing the data set containing the programs. The B would keep the programs from being converted to tape.

For the communications feature, the station transmitting will bypass a data set if the bypass data set field contains a B. For a receiving station, if the bypass data set field contains a B, the data set defined by the data set label will not be bypassed (data will be received and written into the data set).

For the 3540 Diskette Input/Output Unit, a B in position 41 causes the data set to be bypassed during read operations.

Accessibility Field (Position 42): The accessibility field is used to control access to a data set. If this field is blank, the data set is processed. If any character is in this field, the 3741 does not allow the data set to be processed and a disk accessibility (A) error is displayed. For the 3741, this field cannot be modified.

Write Protect Field (Position 43): The write protect field controls writing of records on the disk. If this field is blank, records in a data set are read from the disk and records are written on the disk. If this field contains a P, the data set is write protected (data cannot be written on the disk).

Interchange Type Indicator (Position 44): The interchange type indicator field must be blank. A blank indicates the data set can be used for data interchange.

Multivolume Indicator Field (Position 45): The multivolume indicator field is used to indicate whether a data set is on one or more diskettes. A multivolume data set is a data set that is continued from one diskette to another. A blank in this field indicates that the data set is contained on only one diskette. C is placed in this field if the data set is continued on another diskette. When a data set is continued on several diskettes, this field in the data set label of the last diskette must contain an L. The L means that this diskette is the last for a multivolume data set.

For the 3747, the L means that the data set ends with the data associated with this label. A \emptyset or C means that the data set is not complete with this label.

For the data recorder attachment feature and the I/O adapter, the multivolume indicator field will be described in their respective chapters.

Volume Sequence Number Field (Positions 46-47): The volume sequence number field, an optional field, is used to specify the sequence of volumes in a multivolume data set (data set is on more than one diskette). The sequence must be consecutive, beginning with 01 (to a maximum of 99), if used. If a diskette will be used on the 3540, this field is required.

Creation Date Field (Positions 48-53): The creation date field, an optional field, is used to record the date the data set was created. The format of the creation date can be

YYMMDD, where YY is the year, MM is the month, and DD is the day. An example is: 770704. This is July 4, 1977. If a diskette will be used on the 3540, this field is required.

Expiration Date Field (Positions 67-72): The expiration date field, an optional field, is used to record the date the data set expires. The format of the expiration date is the same as for the creation date. If a diskette will be used on the 3540, this field is required.

Verify Indicator Field (Position 73): The verify indicator field is used by the 3741 to indicate that a data set has been verified by placing a V into this field when the last record of a data set has been verified. This field is blank until the data set has been verified. If a data set was verified and then a change made to the data set (either in enter or update mode), the 3741 replaces the V with a blank.

End of Data Field (Positions 75-79): The end of data (EOD) field, a required field, contains the address of the next sector following the last data record in the data set (the EOD address). The address of the last data record in a data set is EOD minus one. When creating a data set label, the EOD address must be equal to the BOE address.

The EOD address is automatically updated by one each time a record advance occurs in enter mode. In this manner, the 3741 keeps track of the location on disk where the next record can be written. When the operator completes entering records and performs the return to index function, the EOD value in the data set label is modified to the updated EOD value.

Position by Position Representation of Data on the Index Track in Any One Sector of 8-26.		
Field Name	Position	Purpose
Header 1	1-4*	Label identifier for system application; must be HDR1.
	5	Reserved.
Data set name	6-13	Descriptive name for data set.
	14-22	Reserved.
Record length	23-27*	Logical record length.
	28	Reserved.
Beginning of extent (BOE)	29-33*	Identifies the address of the first sector of the data set.
	34	Reserved.

*Indicates this entry is required by the 3740 Data Entry System.

Figure 8 (Part 1 of 2). Data Set Label Layout

Field Name	Position	Purpose
End of extent (EOE)	35-39*	Identifies the address of the last sector reserved for this data set.
	40	Reserved.
Bypass data set indicator	41	The IBM 3747 data converter and the 3741 communication feature require that this field contain a B or a blank. If a B is present, the data set is ignored. If a blank is present, the data set is processed. This coding allows the user to store programs and data on the same disk.
Accessibility	42	This field must contain a blank in order for processing to take place.
Write protect	43	If this field contains a P, the data set can be read only. This field must contain a blank to allow both reading and writing
Interchange type indicator	44	Must be blank. A blank indicates the data set can be used for data interchange.
Multivolume indicator	45	A blank in this field indicates a data set contained on one diskette; a C indicates a data set is continued on another diskette; an L indicates the last diskette on which a continued data set resides.
Volume sequence number	46-47	Volume sequence number specifies the sequence of volumes in a multi-volume data set. The sequence must be consecutive, beginning with 01 (to a maximum of 99), if used.
Creation date	48-53	May be used to record the date the data set was created. The format of the creation date is YYMMDD, where YY is the year, MM is the month, and DD is the day.
	54-66	Reserved.
Expiration date	67-72	May be used to contain the date that the data set expires. The format of the expiration date is the same as for the creation date.
Verify indicator	73	This field must contain a V or a blank. V indicates the data set has been verified.
	74	Reserved.
End of data (EOD)	75-79*	Identifies the address of the next available sector.
	80	Reserved.

*Indicates this entry is required by the 3740 Data Entry System.

Figure 8 (Part 2 of 2). Data Set Label Layout

Data Set Label Error Checking

The 3741 checks to see if any of the following error conditions exist in the data set label:

1. The beginning of extent address is less than track 01, sector 01.
2. The end of extent address is greater than track 74, sector 26.
3. The end of extent address is less than the beginning of extent address.
4. The end of data address is greater than the end of extent address plus 1.
5. The end of data address is greater than track 75, sector 01.
6. The sector is 00 or greater than 26.
7. The record length is equal to 0 or greater than 128 for the 3741.
8. The third character of the record address of beginning of extent, end of extent, or end of data is other than 0.
9. The last record read and currently displayed is from track 00, sectors 1 through 7.
10. The fourth position of the header 1 field is a number other than one.
11. The record has been deleted.

When a header 1 record in sectors 08 through 26 is read, the 3741 checks the first eight conditions in the previous list. If any of these conditions exist, an incorrect data set label (B) error is displayed.

When update, verify, enter, or search mode is attempted from the index track, all 11 conditions are checked. If any one of the 11 conditions is present, the incorrect data set label (B) error is displayed.

Multiple Data Sets Per Disk

For ease of processing, one data set per disk is the best. However, more than one data set can be on one disk. Each data set is identified by its respective data set label on the index track. Each data set label identifies a data set as to its beginning and ending addresses, whether the data set has been verified, the record length, the name of the data set (optional field) and other information about the data set. When a diskette is inserted into the disk drive, the data set label at sector 08 on the index track is always displayed first. If there are other defined data set labels on the index track, the operator can record advance until the appropriate data set label is found. To aid the operator in reviewing and finding the desired data set label, the data set name field (positions 6-13) in the data set label should be used. In addition, the data set label creation date field and the data set expiration date field should also be used when a clear distinction between jobs is needed to ensure the selection of the correct data set. Then in addition to reading the data set name, the operator could also check the creation and expiration dates to ensure processing of the right data set, or the right version of the data set.

Modify Index Mode (M)

The modify index mode is used to modify records on the index track. Fields in a data set label, new data set labels, the volume label, or other records on the index track can be modified by using the modify index mode. Any of the records can also be deleted with the use of the modify index mode function.

- | To perform a modify index function, record backspace or record advance to get to the appropriate index track record to be modified, key the record to be written, then select modify by pressing FUNCT SEL lower and M. The modify mode can be selected from the read index mode only; if it is selected from another mode, a mode selection (M) error occurs. No other mode can be selected from the modify mode. DELETE REC, RESET, and REC ADV are the only valid keys in the modify mode. All others give a function not available (F) error. The mode reverts to read index after the first keystroke following the selection of modify mode.

Enter Mode (E)

Enter mode is the most basic mode of operation. Enter mode can be selected from the index track only; a mode selection (M) error results if enter mode is selected from any other position on the disk. Enter mode is used to write new information on the disk. To select the enter mode, press FUNCT SEL lower and then press ENTER.

As the operator keys a record, the data is stored in the current record buffer until the record is completed. When a record advance occurs, the completed record is transferred to the previous record buffer. While the next record is being keyed into the current record buffer, the previous record is written on the disk.

The data flow is summarized in Figure 9. When enter mode is selected, the disk is positioned at BOE; the current record buffer and the previous record buffer are set to blanks. The station is then ready to accept data keyed into the current record buffer.

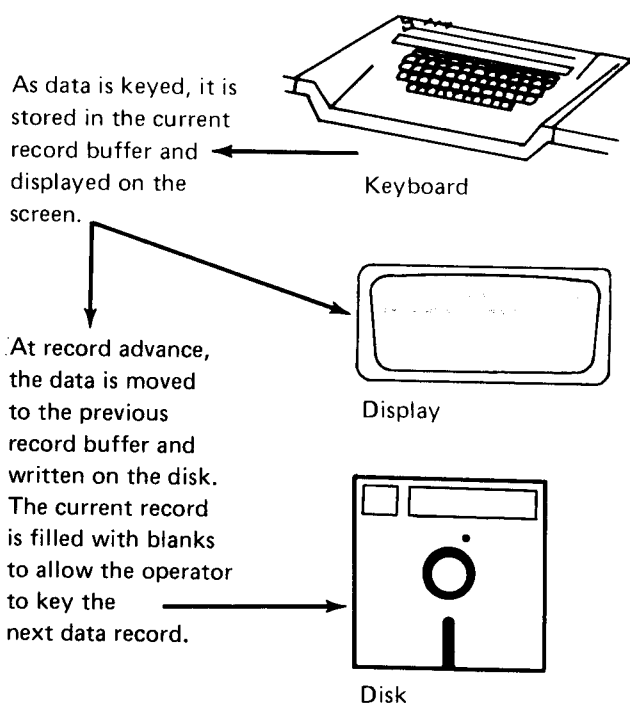

Figure 9. Data Flow for Enter Mode

Alternate Record Advance in Enter Mode

An alternate method of record advance in enter mode can be selected by pressing FUNCT SEL lower and then R. A dash will appear in position 39 in the status line. The record advance function in enter mode is changed so that all fields that follow the position of the cursor at the time of record advance are not executed in contrast to these fields being executed in normal enter mode. The alternate record advance function has this advantage: When the REC ADV key is pressed, the record is always written on the disk exactly as the operator sees it on the display (no automatic duplicate or skip fields are executed). The normal record advance may cause changes in automatic duplicate and skip fields that are beyond the cursor position at the time of record advance.

To return the machine to the normal enter mode, press FUNCT SEL lower and K. Inserting a disk or turning the power on will also establish the normal mode.

Right Adjust Fields

Programmed right adjust fields allow data entered into the current field to be moved to the right field boundary by pressing the RIGHT ADJUST key. Right adjust fields must be at least two characters long and can be as long as a whole record. In enter mode, the RIGHT ADJUST key is used to exit a right adjust field. When the RIGHT ADJUST key is pressed, the 3741 shifts the characters previously entered in the field (up to the cursor position) to the right field boundary. Fill characters are inserted to the left of the first keyed character as required. The fill character used depends on the field definition character used for the field. See *Right Adjust Fields* in Chapter 3.

Pressing the RIGHT ADJUST key in the first position of a right adjust field enters fill characters into the entire field.

The dash (—) key, when used in a right adjust field that is programmed for numeric shift, gives a negative value to the number and then causes the field to be exited. The units (rightmost) position of the negative number contains an alpha equivalent if the digit is 1 through 9 (1=J, 2=K, 3=L, 4=M, 5=N, 6=O, 7=P, 8=Q, 9=R) or the hex code D0 if the digit is 0. The numbers in the other positions of the right adjust field have their numeric value. For example, if 21 is entered in a five-position, zero fill, right adjust field and the dash key is pressed, the field will contain 0002J (negative 21).

Note: Performing a character advance or field advance will cause the right adjust field to be exited in enter mode.

Update Mode (U)

Use the update mode to read records from the disk for review or modification. To select the update mode, press FUNCT SEL lower and then press UPDATE.

Data flow is summarized in Figure 10. Update mode can be selected from the read index, search, or verify mode. If update is selected from the index track, the disk is positioned at BOE; if update is selected from the verify mode, the record at the current disk address is reread. Selecting the update mode from the enter mode results in a mode selection (M) error. However, the mode automatically changes to the update mode when record backspacing occurs during the enter mode. The search mode also automatically changes to update mode at the end of a search operation. An empty data set (Y) error occurs if update mode is selected when the end-of-data address equals the beginning-of-extent address; in other words, when the data set is empty.

If record advance reaches EOD during update mode, the mode of operation automatically changes to enter mode. However, an automatic return to index track is performed if the data set is protected by a write protect byte in the label (a write protect, G, error is displayed) or if the data set is full (an end of extent, E, error is displayed).

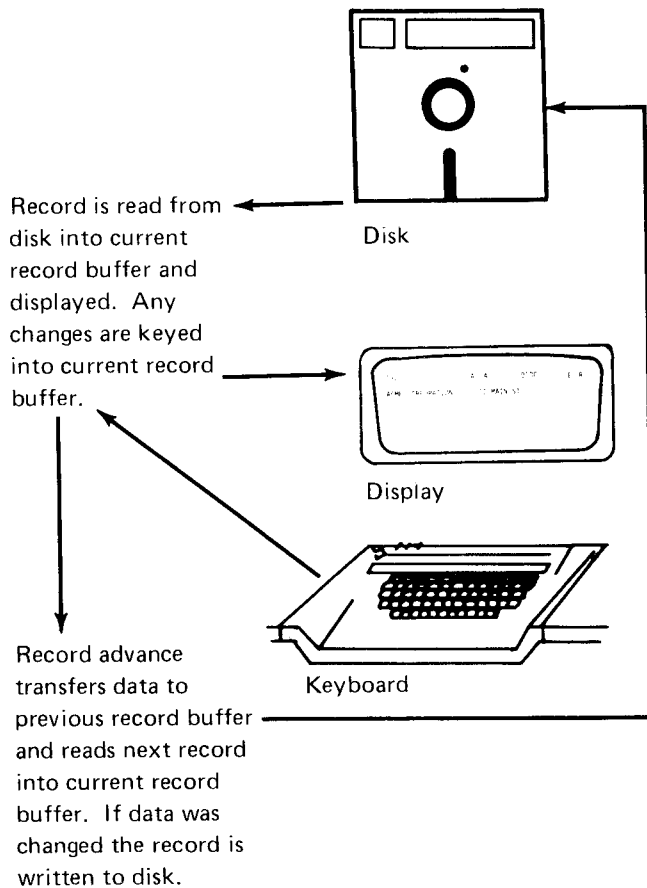

Figure 10. Data Flow for Update Mode

Verify Mode (V)

Use the verify mode to check the accuracy of data records already on the disk and to make corrections to the records when errors are found. The process of verifying data is similar to that of entering data. As the data for a record is rekeyed from the source document, each character is automatically compared with the corresponding character in the record in the current record buffer. If the characters do not compare, a verify mismatch (V) error occurs.

To select the verify mode, press FUNCT SEL lower and then press VERIFY. Select the verify mode from read index or update mode. For data flow, see Figure 11. When verify mode is selected, the previous record buffer is automatically filled with blanks, and the first non-deleted record is read into the current record buffer.

Verify mode can also be selected from verify mode. Selecting verify mode from verify mode is provided in the event that the operator discovers, after making some corrections to the record being displayed, that the wrong source record is being used to verify the record being displayed. By selecting verify mode from verify mode, all changes made to the record are ignored and the entire record is redisplayed.

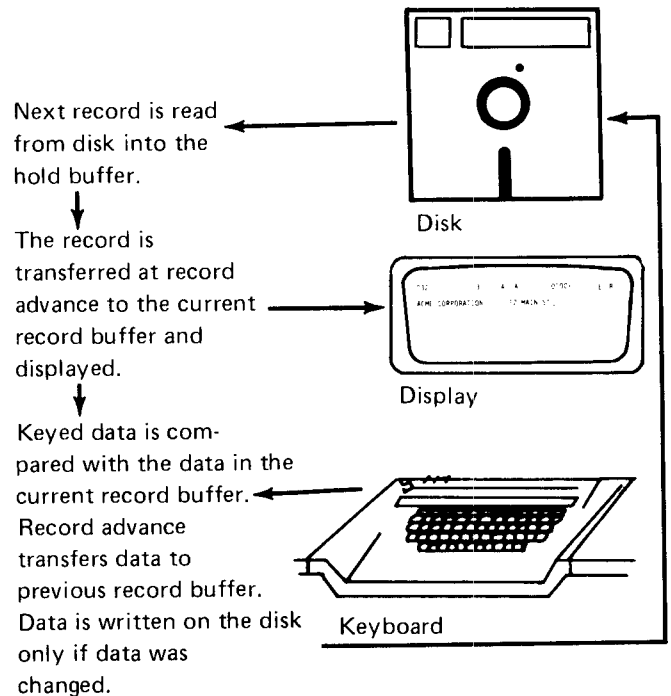

Figure 11. Data Flow for Verify Mode

Display

During verification, the data record is displayed up to but not including the cursor position. However, the *entire* record is displayed (1) after the record is moved into the current record buffer, (2) after a record backspace operation, or (3) when an error occurs. The keystroke following the RESET key returns the normal verify display mode.

Error Correction

If a character keyed while verifying is not the same as the corresponding character in the current record buffer, the following occur:

1. The keyboard locks.
2. A verify mismatch (V) error code is displayed on the status line.
3. The cursor is under the position in error.
4. The entire record is displayed.

Use RESET to reset the error condition and then correct the character in error.

The first character key following the error is accepted if the character keyed agrees with either the character in the current record buffer or the character that caused the error. If the first character key pressed following the error is not accepted, a verify mismatch (V) error is again displayed. The correction process is continued until all corrections have been made to the record.

Skip Functions

If SKIP is pressed or a programmed skip field is encountered during verification, the entire field or the remainder of the field is checked for blanks. If a nonblank character is encountered, the cursor stops in that position, the skip action terminates, and a verify mismatch (V) error is displayed. After pressing RESET, the non-blank character can be replaced with a blank by pressing SKIP. The station then continues to check the remainder of the field for blanks.

Duplication Functions

Pressing DUP or entering a programmed duplication field during data verification causes the rest of the field to be verified automatically. The characters of the record in the current record buffer are compared with the corresponding characters in the previous record buffer. If one of the characters in the record disagrees with the corresponding character in the previous record buffer, a verify mismatch error is posted. After RESET is pressed, the character from the previous record buffer can be inserted into the current record buffer by pressing DUP. The device then continues comparing the field.

When using the auxiliary duplication feature, the characters in the current record are compared with the corresponding characters in program buffer 4.

Right-Adjust Fields

If a right-adjust field is encountered while verifying data, the cursor stays in the first position of the field until the first data key is pressed. The fill characters are compared depending on the field definition characters, and then the first data character keyed is compared with the first nonfill character in the field. If neither agree, an error occurs. When fill characters are in error, the cursor is at the start of the field. When data does not match, the cursor is at the first non-fill character.

To exit from the right-adjust field after verifying the last character in the field, press either RIGHT ADJ or the dash (—) key. RIGHT ADJ and the dash key also verify the field's sign, unless the field is alphabetic. (The dash key is used to verify a numeric field having a minus sign.) If the right-adjust field is alphabetic, the last character in the field is verified in the same way as a character in any other position in the field.

If a verification error occurs while verifying the sign of a right-adjust field, a right adjust sign (X) error is displayed. The sign can be changed by pressing of RIGHT ADJ or the dash key twice.

Press RIGHT ADJ or the dash key, if applicable, to exit from every programmed right-adjust field. Press the key even when one right-adjust field immediately follows another and when right-adjust fields contain all fill characters. Failure to press RIGHT ADJ or the dash key at the end of a right-adjust field causes right adjust (R) error on the next data keystroke.

When a right-adjust field is the last field in a 128-character record on the 3741 and the field has been verified but RIGHT ADJ has not yet been pressed, the cursor position is 129 for the 3741, and the cursor is not displayed.

In verify mode, RIGHT ADJ or the dash key should be used only when the cursor is in the first position of the right-adjust field (to verify a zero or a blank field) or when the field is full (the cursor will have moved to the first position of the next field). If these keys are pressed when the cursor is in any other position, a right adjust (R) error occurs.

Signs

If the units position of a numeric right-adjust field contains a negative number (D zone), the sign and the value of the field are verified separately. The first keystroke for the units position verifies the digit. If the character is corrected, only the digit portion is changed. The sign (D zone) is not affected. To exit from the field, use the dash key. The dash key also verifies the sign.

If the units position of a right-adjust field has a D zone (dash) but the field is alpha, the entire character is compared. If corrected, the entire character is changed. Exit from the field using RIGHT ADJ. To verify a dash character in a numeric right-adjust field, press ALPHA SHIFT with the dash key.

Hexadecimal Data

Verify hexadecimal data in the same way it is entered:

1. Press HEX.
2. Press two character keys corresponding to the hexadecimal digits wanted. The character is verified after the last keystroke for that character.

Record Advance

When a record advance is performed on a corrected record the record is rewritten on the disk as corrected. If there were no corrections to the record, it is not rewritten during record advance. If no verification or correction to a record has taken place and the cursor is in the first manual position of the record, pressing REC ADV causes a record advance function to occur without verification of the record. If a correction had been made to the record, and the cursor is positioned at the first manual position of the record, pressing REC ADV will not cause a record advance

function and the operator is forced to verify the record. Pressing record advance when the cursor is in other than the first manual position of a record causes all remaining automatic skip and manual fields to be verified as blanks; remaining automatic duplicate fields are verified and bypass fields are bypassed.

Verification Code

After the last record in a data set has been verified, a verification code (V) is automatically inserted in the verify field of the data set label, the mode of operation changes to a read index mode, the data set label is displayed, end of extent (E) alert is displayed, and program level 0 is selected.

Field Correct Mode (C)

Field correct mode may be used to correct an entire field with a minimum number of keystrokes. The field correct mode can be selected from the verify mode only. To select the field correct mode, press FIELD COR. The cursor moves to the first position of the current field, and the field can be rekeyed as if in the enter mode. When the end of the field is reached, the cursor then moves back to the first position of the field and the mode changes to verify.

Selecting field correct mode when not in verify mode or while processing a programmed automatic field in verify mode results in a mode selection (M) error. FIELD ADV and CHAR ADV are valid in the field correct mode. The field correct mode changes back to the verify mode when a field or character backspace moves the cursor out of the current field.

Search Mode (S)

Use search mode to:

- Search on record address from read index, update, or enter mode.
- Search to end of data from index, enter, or update mode.
- Search on content from read index or update mode.
- Search on sequential content from read index, update, or enter mode.

For data flow information, see Figure 12.

Note: After pressing any search key, except for search EOD, but before pressing REC ADV, the search operation can be canceled by pressing FUNCT SEL lower and RETURN TO INDEX or by pressing FUNCT SEL lower and UPDATE.

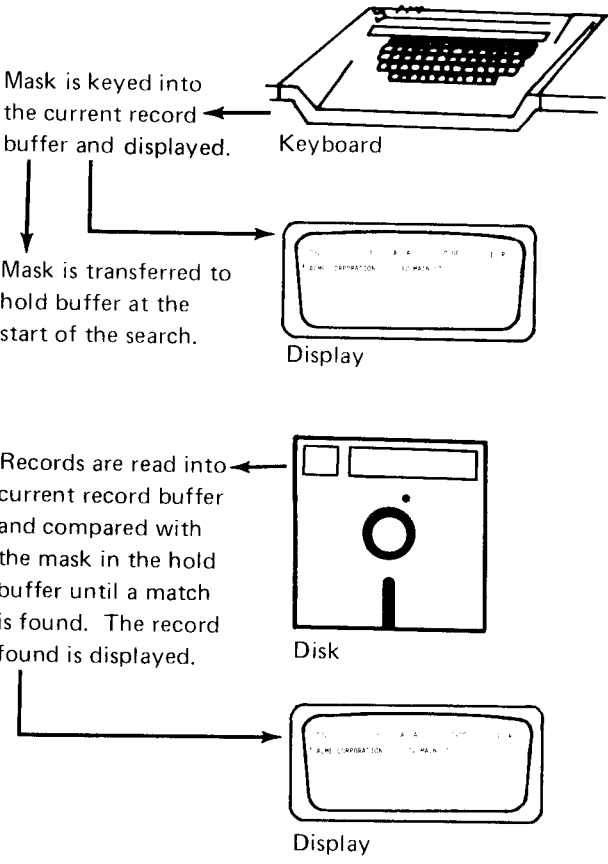

Figure 12. Data Flow for Search Mode

Search on Record Address

Search on record address allows you to search through a data set using record addresses. Search on record address is especially useful if specific records have to be updated and you know the addresses of the records.

To search for a record in a data set, key its track and sector address. The specified address must have the format TTOSS where TT is the track number and SS is the sector number. The record address is keyed into positions 1 through 5 of the display.

The track and sector address specified can be the beginning of extent address, the end of data address minus one, or the address of any record between these two addresses. Select the search mode to do a search by record address operation from the read index, update, or enter mode. Selecting the search by record address function from any other mode causes a mode selection (M) error.

The search stops on the record address specified and the record at the specified address is displayed. The current record buffer and the previous record buffer contain the displayed record at the end of the search and the mode changes to the update mode. The record can now be updated or reviewed. Once the record has been updated or reviewed, another search can be initiated from this address.

A search address (I) error is displayed if the search address is specified incorrectly, if the address is greater than or equal to the end-of-data address or less than the beginning-of-extent address for the data set, or if the address is on the index track. If an invalid address was entered, the cursor moves to the first position of the data line on the display screen.

Search on record address can be used to continue a verify job. This is done by initiating the search and then selecting verify mode when the record at the specified address is displayed.

Search to End of Data

Search to end of data is used when you want to search to the last data record in a data set and begin adding new records to the data set. To search to the last record of a data set, press FUNCT SEL lower and then press SEARCH EOD. Select the search to the end of data function from the read index, enter, or update mode. Selecting from any other mode results in a mode selection (M) error.

When the search is completed, the current disk address is set equal to the last record in the data set and the record is displayed. The contents of the previous record buffer is set equal to the current record buffer and the mode of operation changes to update.

Search on Content

Use search on content to find records that are identified by the content of specified character positions. The specification of the identifying characters and their positions is called a mask. The mask can be any one or more positions of a record and may include the entire record. The mask character positions do not need to be contiguous. The search will stop only on a record that contains an exact match between the record and the search mask. The blank character is used to identify positions that are not included in the mask; therefore, the blank cannot be used successfully as a character within a mask. For example, if a certain field in a record contains ABØCD and the search mask ABØCD is used, the search will stop on the first record that contains AB in the first two positions of the field and CD in the last two positions of the field. Any of the 256 EBCDIC characters might be in the third position of the field.

Searching by content is accomplished in a forward direction, beginning with the next record. The records contained in the current sector and all previous sectors are not checked.

Select the search on content function from the read index or update mode. Selecting this function from any other mode causes a mode selection (M) error to occur.

Following a search operation, the previous record buffer contains the same data as in the current record buffer and the 3741 is in update mode. If the entire data set has been searched and no record found, the search stops and a search (S) error is displayed.

To continue searching for records using the same mask, press FUNCT SEL lower, SEARCH CONTENT, and REC ADV in that order. Do not reenter the search mask.

If a deleted record is read during a search on content and the data in the deleted record does not match the mask, the search continues and a deleted record (6), error appears momentarily on the status line. However, if the data in the deleted record matches the mask, the search stops and the deleted record is displayed.

Occasionally, when searching on fields that are variable length, the search may stop on a record in which a portion of the field in the record being displayed matches the mask. This is because the machine takes the mask, in the positions keyed, and compares the mask to records in the data set searching for the data that matches the mask. (Remember that the blank positions in the mask identify the positions of the record that will not be checked.) Therefore, a portion of a field could satisfy the mask even though it is not the record the operator desires. For example, if a mask of

SMITH was keyed in positions 1 through 5 and the search was initiated, it is possible that the machine may find SMITHSON (with SMITH in positions 1 through 5) to be a match if the machine encountered SMITHSON before it encountered SMITH.

If the machine stops the search with the wrong record displayed, the operator should continue the search content operation from the address where the search stopped to see if the record can be found.

To reduce or eliminate the possibility of the machine stopping a search on record that does not completely match the mask, it is suggested that the search be performed on fields that contain no blanks.

Search on Sequential Content

Search on sequential content is similar to search on content, but is faster. Search on sequential content requires a mask just as search content does. Use search on sequential content only when the records in a data set are arranged so that the search fields are in ascending order (the search field of each succeeding record must have a higher value than the preceding record). See Figure 13 for the collating sequence which can be used to determine character values and which characters have higher values than others. Having the search fields in ascending order permits faster searching because of the skipping of records.

Search on sequential content operates in either a forward or backward direction; therefore, a record can be located when the search is started at a higher address than that of the record being searched.

If a search fails to find the record sought, a search (S) error is displayed. Failure to find a record can occur even though the record is in the data set if one or more records do not meet the requirement of ascending order. Therefore, after a search failure, a search on content may be initiated using the same search mask. To do this operations, first return to the index track in order to search through the entire data set.

Select search on sequential content from the read index, enter or update mode. When a match occurs, the record is displayed and the 3741 is in update mode.

EBCDIC Collating Sequence		
Order in the Sequence	Character	Corresponding Hexadecimal Number
1 (lowest)	Blank	40
2	¢	4A
3	.	4B
4	<	4C
5	(4D
6	+	4E
7		4F
8	&	50
9	!	5A
10	\$	5B
11	*	5C
12)	5D
13	;	5E
14	7	5F
15	-(minus)	60
16	/	61
17	,	6B
18	%	6C
19	— (underscore)	6D
20	>	6E
21	?	6F
22	:	7A
23	#	7B
24	@	7C
25	' (apostrophe)	7D
26	=	7E
27	”	7F
28	A	C1
29	B	C2
30	C	C3
31	D	C4
32	E	C5
33	F	C6
34	G	C7
35	H	C8
36	I	C9
37	J	D1
38	K	D2
39	L	D3
40	M	D4
41	N	D5
42	O	D6
43	P	D7
44	Q	D8
45	R	D9
46	\	E0
47	S	E2
48	T	E3
49	U	E4
50	V	E5
51	W	E6
52	X	E7
53	Y	E8
54	Z	E9
55	0	F0
56	1	F1
57	2	F2
58	3	F3
59	4	F4
60	5	F5
61	6	F6
62	7	F7
63	8	F8
64 (highest)	9	F9

Figure 13. Collating Sequence

Occasionally, when searching on fields that are variable length, the search may stop on a record in which a portion of the field in the record being displayed matches the mask. This is because the machine takes the mask, in the positions keyed, and compares the mask to records in the data set searching for the data that matches the mask. (Remember that the blank positions in the mask identify the positions of the record that will not be checked.) Therefore, a portion of a field could satisfy the mask even though it is not the record the operator desires. For example, if a mask of SMITH was keyed in positions 1 through 5 and the search was initiated, it is possible that the machine may find SMITHSON (with SMITH in positions 1 through 5) to be a match if the machine encountered SMITHSON before it encountered SMITH.

If the machine stops the search with the wrong record displayed, the operator can backspace a few records to see if the proper record can be found. If it cannot be found, the operator should perform a return to index function and initiate the search content function using the same mask to see if the record can be found.

To reduce or eliminate the possibility of the machine stopping a search on a record that does not completely match the mask, it is suggested that the search be performed on fields that contain no blanks.

Field Totals Mode (F)

Field totals can be used for batch auditing, a process sometimes referred to as "hash totals", or for other applications that require totals. The 3741 has two kinds of field totals capability: online and offline.

The online field totals feature can be used to obtain totals from records while entering the records in enter, update, or verify mode. The offline field totals feature is used to obtain totals from records that have been entered, updated, or verified.

HEXADECIMAL DATA

The HEX key provides a method of entering any of the 256 EBCDIC characters into a data record. Valid hex digits are: 0, 1, 2, 3, 4, 5, 6, 7, 8, 9, A, B, C, D, E, F. Hex characters are entered by pressing HEX and then keying two hex digits. Hexadecimal data is verified in the same manner. HEX can also be used like a multipunch key on a keypunch machine except that the characters combined are sometimes different from the keypunch and they must be keyed in a certain order.

Multipunch Operations

HEX can be used to perform the equivalent of multipunch on card keypunch machines. See Appendix B for card punch to hexadecimal conversions.

The important multipunch operations are overpunching with 11, 12, and 0 punch. The following procedures are valid for overpunching numerics 0 through 9.

11 Punch: For the 11 punch, first press HEX, then press the D key or the dash (—) key, and then the numeric key (0 through 9). The 11 overpunch in the units position of a numeric field indicates a negative value.

12 Punch: For the 12 punch, first press HEX, then press the C key and then press the numeric (0 through 9).

0 Punch: For the 0 punch, first press HEX, then press the E key and then the numeric key if the numeric is 2 through 9. If the numeric is a 1, the procedure is to press HEX, then press the 6 key and then the 1 key. If the numeric is a 0, do not use HEX, just press the 0 key. (Overscoring a zero with a zero on a punched card punches the same hole twice resulting in no change from a single zero punch.)

Hexadecimal Display

When hex data is keyed or displayed, not all of the data represents displayable characters such as A B C... or 0 1 2 3... When the hex data keyed is not a displayable character, a hexadecimal display is provided that represents the eight bit code for the data. The basic display (no bits on) looks like this:

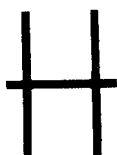

Other lines are added to the display for each bit that is on in the EBCDIC code.

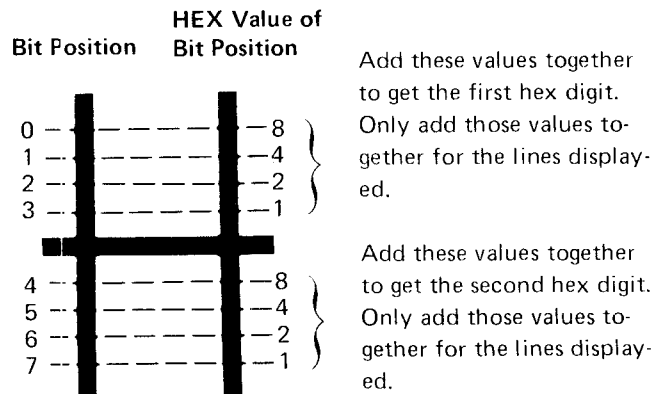

Example: Assume the display looks like this:

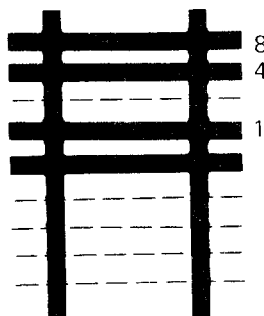

The first hex digit is $8 + 4 + 1 = D$ and the second hex digit is a 0. The hexadecimal value is hex D0.

Assume another display looks like this:

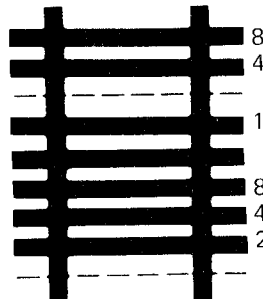

The first hex digit is $8 + 4 + 1 = D$ and the second hex digit is $8 + 4 + 2 = E$. The hexadecimal value is hex DE.

DELETED RECORDS

A record is identified as either deleted or non-deleted by the data address mark which precedes the first character of the record. This address mark (one of two in each sector of a disk) is not part of the data and is not displayed.

If a record is deleted, the data address mark identifies the record as deleted. Depending on the procedure used to delete the record, the first character of the data record can be preserved or automatically replaced with the character D. To delete a record and preserve the first character of the data record, press FUNCT SEL lower and then press NUM SHIFT with DELETE REC. To delete a record and automatically replace the first character of the data record with a D, see *IBM 3741 Data Station Operator's Guide*, GA21-9131.

When the 3741 reads a record, it examines the data address mark to see if the record is a deleted record. If the data address mark indicates the record is deleted, a 6 error is displayed in the status line. Since the 3741 does not check for a D in the first position of the data record, the operator must use the 6 error to identify deleted records.

To change a deleted record to a non-deleted record, the record must be rewritten. To do this, key a change to the record and press REC ADV. To rewrite a record in the Index mode, press FUNCT SEL lower, press M, and then press REC ADV.

Notes:

1. In the Index mode, a record is rewritten even if no change is keyed to the record. That is, the record has a D in the first position but the record is not a deleted record.
2. When the 3747, 3540, or any other system reads a record, it examines both the data address mark and the first position in the data record for a D. If the data address mark identifies a deleted record, but the first position in the data record is not a D, a halt will occur with an error condition. Therefore, if the diskettes are to be processed by other than a 3741 Model 1 or 2, or a 3742, or if a data set is used as input from a directly attached 3741, the procedure for deleting records and preserving the first data character should not be used. If the diskettes are processed by a 3741 Model 3 or 4, see *IBM 3741 Models 3 and 4 Programmable Work Station Programming Reference Manual*, GA21-9194, for information on deleted records requirements. Also, for more information, see *Control Records* in *The IBM Diskette General Information Manual*, GA21-9182.

Mode Considerations for Deleted Records

Enter Mode: Using DELETE REC during enter mode blanks the current record buffer and positions the cursor at the first manual position. The previous record buffer is unchanged.

Update Mode: If, during update mode selection, a deleted record is read into the current record buffer, the previous record buffer will contain the same deleted record. If a deleted record is in the current record buffer when a record advance occurs during update mode the record is not transferred to the previous record buffer. If a deleted record is encountered during record backspacing, the previous record buffer is not changed.

When deleting a record, the first character is changed to a D in the current record buffer, and the remainder of the content in the current record buffer remains unchanged.

Verify Mode: When selecting verify mode from the index track, the first nondeleted record in the data set is read into the current record buffer.

If verify mode is selected from update or verify mode and the currently displayed record is a deleted one, the next non-deleted record is read into the current record buffer. In either case, the previous record buffer is blanked.

When a record advance occurs and a deleted record is in the hold buffer (next sequential record is deleted), the next non-deleted record is read into the current record buffer by-passing all deleted records encountered. If a deleted record is encountered during record backspacing, the deleted record is read into the current record buffer with the previous record buffer unchanged.

When deleting a record, the contents of the previous record buffer remains unchanged and a record advance function is performed.

Search Mode: Using DELETE REC during search mode blanks the current record buffer and positions the cursor at the first manual position. The previous record buffer and the record at the current disk address are unchanged. If the search operation terminates on a deleted record, both the current and previous record buffers contain the deleted record.

RECORD INSERT FEATURE

With this feature, you can insert records within a data set as shown below.

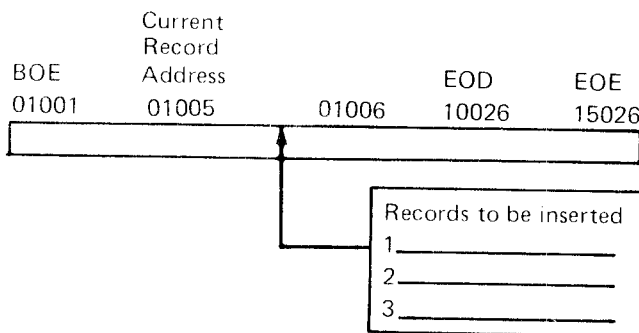

To insert records into a data set, the record insert function performs an operation which creates space in the data set for the number of records to be inserted. The 3741 puts deleted records in the space created. The deleted records have a D in position 001 and a \ (inverse slash) in position 002. The remainder of the record is blank.

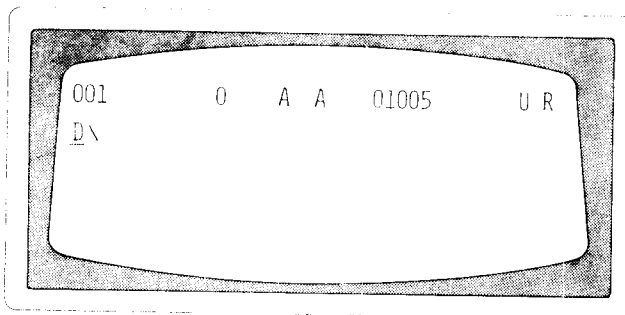

If you want to insert five records on track 01 beginning with sector 05, the 3741 would put five deleted records in sectors 05 through 09.

To create space in the data set, the 3741 moves the records from the current record address through the last record in the data set. The 3741 moves these records as many sectors as the number of records to be inserted (up to 99). An example of creating space for five records:

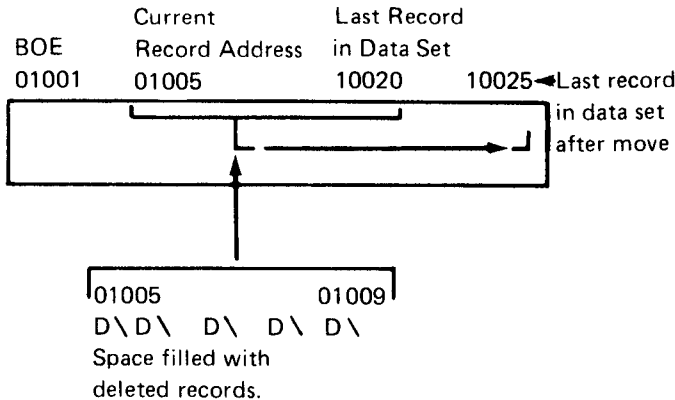

When using the record insert function, there must be enough space between EOD and EOE specified in the data set label. That is, if you want to insert 50 records, but only have 40 sectors available, (from EOD to EOE) in the data set, an error occurs.

If all of the space created is not used, the remaining deleted records will be ignored when processing data. If you have deleted records, you must reset the deleted record (6) error which the 3741 displays with each deleted record. Therefore, if enough space was not specified for the number of records to be inserted, you will realize it when you do not get the deleted record (6) error. Search on content can be used to search for the D\ when records will be inserted at some other time.

Record Insert Mode Characteristics

Enter Mode

No records are moved in this mode but it allows you to create a space within your data set for records you might want to add later. Deleted records are added starting at the current disk address for the number of records specified.

Update Mode

The machine searches to the last record in the data set. Then it reads records in groups starting at this address and rewrites these records at their new addresses. After moving all the records, the 3741 adds deleted records at the specified disk address for the number of records specified.

Verify Mode

The Record Insert mode cannot be selected while the 3741 is in the Verify mode. The 3741 must be placed in Update mode before the Record Insert mode is selected.

Read Index Mode

The 3741 moves all records in the data set as if in Update mode. Then the machine adds deleted records at the BOE address.

Search Mode

The action taken by the machine depends on the mode it was in prior to selecting Search mode. See one of the above.

When all the records have been moved and the space filled with deleted records, the 3741 returns to the disk address of the first record of the space created.

The machine goes to update mode regardless of the mode you were in previously. The machine also displays a deleted record (6) error, goes to program 0, and blanks the hold buffer.

ADDING RECORDS TO A BATCH

Verify operations, batch control totals, and 3747 record counts can indicate that records are missing. Records that are missing may be added to the end of the batch, or may have to be added somewhere in the middle of the batch. Records may also have to be added to a batch if they become available after the batch to which they belong has been keyed.

The easiest way to add records to a batch is to add them to the end of the batch. To do this, the operator searches (by using search EOD operation) to the end of the data position in the data set. When the search is finished, the last record in the data set is displayed. The operator then presses REC ADV to get to the next record position where data can be entered. The missing records can then be added to the data set.

Some data sets may consist of records that are sequence sensitive. To handle addition of records to sequence sensitive data, the following procedure can be used on 3741's with the Disk Copy feature.

1. Determine the proper address at which records must be inserted, according to the sequence of data.
2. Insert the diskette from which records will be copied into the disk 2 disk drive.
3. Insert a scratch diskette (the records will be copied onto this diskette) into the disk drive.
4. Press FUNCT SEL lower and ENTER.
5. Press FUNCT SEL upper and DISK 2 RET TO INDEX.
6. Press FUNCT SEL lower, hold down the numeric shift key, press SEARCH ADDRESS, key in the address of the next record after the address at which you wish to begin to write.
7. Press FUNCT SEL upper, hold down the numeric shift key, and press COPY.
8. When the address entered is reached, all the records have been copied onto disk 1 except for the record displayed.
9. Enter the records to be added.
10. Press FUNCT SEL upper, hold down the numeric shift key, and press COPY. This step copies the remainder of the records still on disk 2 onto disk 1.
11. When the copy is complete, press FUNCT SEL lower and RETURN TO INDEX.

DATA RECOVERY

The most significant recovery step in data recovery is to re-establish the EOD address of the partially destroyed data set. The old EOD address is destroyed on a data set label under the following conditions:

- The operator inadvertently selected a data set label of a data set that contains currently valid data, selected enter mode, performed at least one record advance and then returned to the index track.
- The operator removed the diskette from the disk drive before return to index was pressed or before X R was displayed on the status line when RETURN TO INDEX was pressed.

Recovery of the data sets original EOD address, if known, is a simple data set label modification of the EOD field.

If the EOD address is not known, one of the following procedures should assist in determining the EOD address for the data set by finding the last record of the data set.

Procedure 1:

- Modify the EOD field in the data set label with an estimated EOD address.
- Execute a search EOD operation and examine the record displayed. If the displayed record is recognized as a valid record within the data set but is not the last record, return to the index track and repeat *procedure 1* using a higher estimated EOD address. If the displayed record is not recognized as a valid record within the data set, press record backspace until the last record in the data set is found.

Procedure 2:

- If the last record content is known, modify the EOD field in the data set label to the EOE address plus one and perform a search on content operation using the last record as the search mask. When the search stops, the last record entered should be displayed.

When the last record of the data set is found, perform the following:

1. Press REC ADV.
2. Write down the address.
3. Perform a return to index operation.

4. Modify the EOD field in the data set label with the recorded address.
5. Execute a search EOD operation to validate the EOD address.
6. If the operator had originally keyed over currently valid data, the records should be examined and corrected.

On occasion, an operator will remove a diskette from the disk drive before pressing RETURN TO INDEX. When this happens, there is the possibility that the EOD address will not be correct because the only time that the address is updated is when the return to index function is performed. The preceding procedures should also be used for this situation.

BAD SPOTS ON DISK

If a record cannot be read from or written onto disk, the copy function can be used to copy surrounding data and then manually key the bad record. Alternate methods depend on the mode the station is in when the error occurs: Enter mode — return to index and continue the batch on a new diskette. Verify or Update mode — backspace several records and then record advance to see if the problem will clear itself; if not, delete the record and add it to the data set (see *Adding Records to a Batch* in this section).

The following are recovery procedures to follow when disk errors 2, 3, 4, and 5 persist.

No Record Found (2) Error

A no record found error occurs when the address that identifies the location of a record on disk is defective.

- If the error occurs when record advancing in update mode, the display is blank.
- If the error occurs when record backspacing in enter or update mode, the record displayed when the record backspace key was pressed remains displayed.
- For verify mode, the record on which the no record found error occurred is the next record to be verified, not the current record being verified and displayed. The operator can reset the error, complete verification of the current record, and press REC ADV. The record displayed after pressing REC ADV is the record just verified.

- For all other modes, the record read prior to the no record found error is displayed.

When the no record found error persists, perform the appropriate copy operation to copy the data. The *IBM 3741 Data Station Operator's Guide*, GA21-9131 provides copy procedures.

Follow the procedures in the operator's guide for error recovery when the no record found error occurs while copying. Be sure to identify the diskette on which the no record found error occurred as being defective. The defective diskette should be initialized.

Seek (3) Error

A seek error occurs when the address that identifies a track is defective. When the seek error occurs, the 3741 either returns to the index track or remains within the data set depending on the mode of operation. When the seek error persists, perform the appropriate copy operation to copy all of the disk. The *IBM 3741 Data Station Operator's Guide*, GA21-9131 provides copy procedures. Follow the procedures in the operator's guide for error recovery when the seek error occurs while copying. Be sure to identify the diskette on which the seek error occurred as being defective. The defective diskette should be initialized.

Disk Read (4) Error

A disk read error occurs because a portion of the record, or the entire record read is in error. However, the record on which the read error occurred is displayed even though a portion or all of the record is in error. If the read error persists after being reset several times, the following can be performed to try and correct the error.

Note: For verify mode, the record on which the read error occurred is the next record to be verified, not the current record being verified and displayed. Therefore, the operator can reset the error and complete verification of the record and then press REC ADV. The record on which the read error occurred is then displayed.

If you can identify what data is incorrect in the record, correct the data and press record advance. If no write error (5) occurs, the record has been written to disk correctly and it should be read properly.

If a write error does occur after pressing record advance, the sector is probably defective. Reset the write error and perform a delete record operation. If the delete record operation is successful (no write error), add the record to the end of the data set.

If the delete record operation is not successful, or if the record cannot be added to the end of the data set, the copy operation can be used to copy the surrounding data and then manually key in the record. Be sure to write the track and sector address on the external label of the diskette on which the error occurred. The diskette should be initialized.

Disk Write (5) Error

A write error occurs when a record is not written on disk correctly. When a write error persists, perform a delete record operation. If the delete record operation is successful (no write error), add the record to the end of the data set.

If the delete record operation is not successful, or if the record cannot be added to the end of the data set, the copy operation can be used to copy the surrounding data and then manually key in the record. Be sure to write the track and sector address on the external label of the diskette on which the error occurred. The diskette should be initialized.

CE MODE

CE mode is used by the customer engineer when testing or troubleshooting the equipment. This manual does not describe how this mode works or how it is used but merely points out how it is entered and how to get out of the mode.

Pressing FUNCT SEL lower, NUM shift, and C puts the machine in the CE mode. The status line displays CER in positions 38, 39 and 40.

Pressing RESET several times returns the machine to the index mode with the label from sector 08 displayed. After the machine leaves CE mode, the program buffers of the 3741 may be changed and therefore should be checked. The CE mode may modify the EOD field and the verify indicator field of the data set label for the data set being used when CE mode was selected. Therefore, those fields should be checked and corrected if in error.

Programs similar to those used on the IBM 029 Card Punch can be written for use on the 3741. A program is written to control the record format and assist the operator as records are keyed. Programs are first keyed into the current record buffer (as data is keyed in enter mode) from which they can be stored on the disk (for later program loading and selecting) or stored directly into a program buffer. If programs are stored on disk, they can be stored in a data set separate from the data or on a program disk (a disk that contains only programs). For information on loading a program, selecting a program, displaying a program, or modifying a program, see *IBM 3741 Data Station Operator's Guide*, GA21-9131.

The 3741 provides storage for up to ten programs, numbered 1 through 9 and A. The operator loads programs and selects programs by these numbers. The selected program number is displayed to the operator in the status line at position 12. When operating under manual control program buffer number 0 is displayed in the status line. Program buffer 0 is a single character all alpha field program. When the machine is turned on, program buffer 0 is automatically selected and all program buffers (1 through 9 and A) are filled with N's (numeric field).

PROGRAM CODING

A program defines the format of the record for the operator. A program defines the:

- Position at which each field in a record starts.
- Type of each field in the record.
- Length of each field.
- Last position of the record.

A program consists of field definition characters, field continuation characters, and the end of program character.

A field definition character defines the type of field and indicates where each field in the record begins. (The field definition character of the field being processed is displayed in the status line.) If a field is more than one position long, the field definition character is followed by the appropriate field continuation characters (the field definition character and the continuation characters must equal the length of the field). For a list of field definition characters, continuation characters, and their meanings, see Figure 14.

The end of program character (E) normally follows the last field definition or continuation character. Programs that are 128 characters long for the 3741 do not require the E character. When the cursor reaches a position containing an E character in the program, a record advance occurs if the AUTO REC ADV is on. If this switch is off, the following characters in the status line are changed: the field definition character is set to E, the field continuation position is blanked, and the cursor position is set to 000 on the 3741. REC ADV should be pressed to write the record on the disk. Keying data when the cursor position is at 000 causes a truncation (T) error.

Program Field Descriptions

Field Continuation Characters

Field continuation characters follow a field definition character and are used to indicate the shift (numeric or alpha) and the length of the field (the field definition character plus the number of continuation characters must equal the field length). The field continuation characters are: dash (—) for numeric and period (.) for alpha. If desired, field continuation characters can be intermixed within any particular field.

Field Definition Characters	Keyboard Shift	Meaning
N	Numeric	Numeric field
A	Alpha	Alphabetic field
B	Not applicable	Unconditionally bypass the field
J	Numeric	Right adjust numeric field with blank fill characters
R	Numeric	Right adjust numeric field with zero fill characters
I	Alpha	Right adjust alphameric field with blank fill characters
D*	Numeric	Automatically duplicates
U*	Alpha	Automatically duplicates
S*	Numeric	Automatically skips
K*	Alpha	Automatically skips
V	Numeric	Bypass numeric field during verify mode only
W	Alpha	Bypass alphabetic field during verify mode only
X	Numeric	Bypass right adjust numeric field with zero fill characters during verify mode only
Y	Numeric	Bypass right-adjust numeric field with blank fill characters during verify mode only
Z	Alpha	Bypass right-adjust alpha field with blank fill characters during verify mode only
H	Numeric	Self-check, modulus 10 field
C	Numeric	Self-check, modulus 11 field
F*	Numeric	Self-check, modulus 10 skip field
G*	Numeric	Self-check, modulus 11 skip field
L*	Numeric	Self-check, modulus 10 duplicating field
M*	Numeric	Self-check, modulus 11 duplicating field
Any fields definition character followed by 1, 2, or 3	Not applicable	Field totals entry
Any B field followed by 4, 5, or 6	Not applicable	Field totals readout field (for offline field totals)
Any B field followed by 7, 8, or 9	Not applicable	Field totals readout and reset field
- (dash)	Numeric	Continuation character for numeric fields
. (period)	Alpha	Continuation character for alphameric fields
E	Not applicable	Indicates the end of the program

} Continuation characters can be mixed in a field.

*These are automatic fields only with the AUTO DUP/SKIP on.

Figure 14. Field Definition Characters

Manual Numeric Fields

The numeric field definition character, N, defines a manual numeric field. The N is followed by the dash (–) continuation character. The number of dashes required depends on the field length. The N plus the dashes must equal the field length. If the field is only one position, only the N is required. Any position in a numeric field can be overridden by using the alpha shift key.

If a manual numeric field does not have to be verified, use the V field definition character instead of the N field definition character. The V indicates to the 3741 that, when in verify mode, the corresponding manual numeric field in the data record does not have to be verified and the 3741 will bypass the field.

Manual Alphabetic Fields

The alphabetic field definition character, A, defines a manual alphabetic field. The A is followed by the period (.) continuation character. The number of periods required depends on the length of the field. The A plus the periods must equal the field length. If the field is only one position only the A is required. Any position in an alphabetic field can be overridden by using the numeric shift key.

If a manual alphabetic field does not have to be verified, use the W field definition character instead of the A field definition character. The W indicates to the 3741 that, when in verify mode, the corresponding manual alphabetic field in the data record does not have to be verified and the 3741 will bypass the field.

Unconditional Bypass Fields

The unconditional bypass field definition character, B, causes the 3741 to bypass the field. The B can be followed by either dashes (–) or periods (.) continuation characters. The number of continuation characters required depends on the length of the bypass field. The B plus the continuation characters must be equal to the length of the field. Field totals readout and readout/reset fields are indicated by using the B field definition character. A B followed by a 4, 5, or 6 indicates a field totals readout field, and a B followed by a 7, 8, or 9 indicates a field totals readout and reset field. Again, either continuation character can be used to fill out the remainder of the field. For complete information on programming field totals fields, see *Chapter 6. Offline Field Totals*.

Right Adjust Fields

Right adjust fields allow data to be right adjusted when entered into a data record. For example, assume that there is a right adjust field that is 10 positions long and 12345 is keyed into the field. Before the right adjust key is pressed, the field would look like this: DATA...12345-~~00000~~. After the right adjust key is pressed, the field would look like this: DATA...~~00000~~12345. The right adjust field definition characters are J, R, I, X, Y, Z. Right adjust fields must be at least two characters long.

The J field definition character defines a numeric right adjust field that has blank fill characters. Fill characters are characters that are placed in front of the right adjust data. If a numeric right adjust field with blank fill characters does not have to be verified, use the Y field definition character instead of the J field definition character. The Y indicates to the 3741 that, when in verify mode, the corresponding right adjust field in the data record does not have to be verified and the 3741 will bypass the field.

The R field definition character defines a numeric right adjust field that has zeros for fill characters. If a numeric right adjust field does not have to be verified, use the X field definition character instead of the R field definition character. The X indicates to the 3741 that, when in verify mode, the corresponding right adjust field in the data record does not have to be verified and the 3741 will bypass the field.

The I field definition character defines an alphabetic right adjust field that has blanks for fill characters. If an alphabetic right adjust field does not have to be verified, use the Z field definition character instead of the I field definition character. The Z indicates to the 3741 that, when in verify mode, the corresponding right adjust field in the data record does not have to be verified and the 3741 will bypass the field.

Duplicate Fields

Fields can be programmed as duplicate fields. This means that the field in the current record can be duplicated from the previous record. The field is duplicated automatically when the AUTO DUP/SKIP switch is on. If the AUTO DUP/SKIP switch is off, the field appears as a manual alpha or numeric field depending on the field definition character. Duplicate fields can be alphabetic or numeric. The duplicate field definition characters are D and U. The D field definition character defines a numeric duplicate field and the U field definition character defines an alphabetic duplicate field. Follow the field definition character used (D or U) by the appropriate continuation character (dash or period) to complete the duplicate field.

An additional duplicate function called auxiliary duplication is available. For the auxiliary duplicate function, the data to be duplicated into the current programmed duplicate field in the record is obtained from program buffer 4. The data in the program buffer must be in the same positions as the field in the current record. More than one field can be duplicated from program buffer 4 if desired. All that is required is that, for each field to be duplicated, the data in the program buffer be in the same positions as the duplicate fields in the record. Program buffer 4 is loaded with the duplicate data just as if a program were being loaded into the buffer. The auxiliary duplicate function is initiated by pressing NUM SHIFT and DUP. The auxiliary duplication function is useful when data is to be duplicated into certain records, such as header records.

Skip Fields

Fields can be programmed as skip fields. This means the 3741 will fill the field programmed as a skip field with blanks and then go to the next field. In verify mode, skip fields are checked for blanks. The skip field is skipped automatically when AUTO DUP/SKIP is on. If the AUTO DUP/SKIP switch is off, the field appears as a manual alpha or numeric field depending on the field definition character. Skip field definition characters are S and K. The S field definition character defines a numeric-skip field and the K field definition character defines an alphabetic skip field. Follow the skip field definition character used (S or K) by the appropriate continuation character (dash or period) to complete the field.

Self-Check Fields

Self-check fields provide a method for checking the entries in numeric fields that contain a precomputed self-check digit. The field definition characters for self-check fields are H, C, F, G, L, and M. The F, G, L, and M characters are automatic field definition characters (AUTO DUP/SKIP must be on).

The H and C field definition characters define manual numeric self-check fields for modulus 10 and modulus 11 respectively.

The F and G field definition characters define automatic numeric skip self-check fields for modulus 10 and modulus 11, respectively. In verify mode or field correct mode, these fields are handled as bypass fields with only the self-check computation being performed when the self-check feature is installed. If the self-check feature is not installed on the 3741, the fields are handled as an auto skip field (verified for blanks).

The L and M field definition characters define numeric automatic duplicate self-check fields for modulus 10 and 11, respectively.

For more information on self-check, see *Chapter 9. Self-Check Feature*.

Creating and Storing Programs

There are two basic approaches to creating programs, based on responsibility for creation. The first approach follows the procedure used in many of today's card punch installations, where each operator has the responsibility to make up and maintain program cards. With the 3741 system, an operator can simply key and maintain programs on the disk, rather than program cards. One disk can hold as many as 1898 programs.

The second basic approach is that of having a supervisor, lead operator, or system engineer create all of the programs for every operator in the installation. Here the responsible person keys all of the programs for the installation, then makes copies of the master program disk for all operators. Each operator then has a program disk, as in the first approach; the only difference is that the program disks were prepared centrally.

Centrally prepared program disks are maintained by changing existing programs or adding new ones to the master program disk. Copies are then made and issued to each operator. The effective date of the program disk can be noted on the external label, thus indicating whether the program disk is the latest version.

With either method of program disk preparation, the programs must be organized in some manner so that they can be located again. The simplest approach is to key the programs on the disk in any desired sequence, keep track of the addresses, and then locate the record by using search on record address.

Another method is to arrange each group of programs on a separate track, for example:

<u>Address</u>			
<u>Track</u>		<u>Sector</u>	<u>Programs</u>
01	0	01	Accounts receivable
01	0	02	Accounts receivable
02	0	01	Payroll
02	0	02	Payroll
02	0	03	Payroll
03	0	01	Accounts payable
03	0	02	Accounts payable

In this example, the accounts receivable job has two program levels, starting in track 01, sector 01. Payroll has three program buffers starting in track 02, sector 01, and so on. By arranging each group of programs on a separate track, allowance is made for adding new programs.

If, after keying these programs onto a disk, the operator wants to load the payroll programs, the operator performs a search on record address, keys in 02 (track) 0 01 (sector), and presses REC ADV. When the first of the three payroll programs is displayed, the operator presses FUNCT SEL and PROG LOAD, and keys number 1. This loads the first program into program buffer 1. By pressing REC ADV, selecting PROG LOAD, and keying the number 2, the next program is loaded into program buffer 2. The third payroll program is loaded into program buffer 3 in the same way.

Another approach would be to organize the program disk as follows:

<u>Address</u>			
<u>Track</u>		<u>Sector</u>	<u>Record</u>
01	0	01	Accounts receivable (header)
01	0	02	Accounts receivable program 1
01	0	03	Accounts receivable program 2
02	0	01	Payroll (header)
02	0	02	Payroll program 1
02	0	03	Payroll program 2
02	0	04	Payroll program 3
03	0	01	Accounts payable (header)
03	0	02	Accounts payable program 1
03	0	03	Accounts payable program 2

In this example, each job has a header record recorded on the disk preceding the actual program. A header record contains descriptive information about the programs. A typical header record for payroll programs would be as follows:

PAYROLL PROGRAMS-EMPLOYEE MASTER, DAILY TIME, DEDUCTIONS.

Messages can also be included in the header program. To find the payroll program using this approach, the operator performs a Search on Content, keys in the word Payroll, then presses REC ADV. This causes the data station to search for the Payroll header record. The operator then presses REC ADV, selects program load, and loads as many programs as needed for that job.

Thus far, the methods of creating and storing programs have assumed a program disk for each operator. The other basic system approach is to include programs on the same disks that are to contain data.

For simplicity, assume an installation has only 20 programs for all of the jobs to be performed on the 3741. Each disk in the installation can have a bypass data set label established for track 1 (26 sectors), in which programs are to be recorded. The second data set label can be established to reserve tracks 2 through 73 for data.

Thus, an operator can insert a diskette, search for the desired program, load it, and proceed to enter data on the same diskette. The procedure would be as follows:

1. Insert diskette.
2. Search for a program (record address or search on content).
3. Load program(s).
4. Press the return to index key. (This returns the read/write head to the index track, the label for the program data set.)
5. Press the record advance key. (This increments to the next sector on the index track, which in this case would be the data set label for the data portion of the disk.)
6. Select a mode. (The read/write head is positioned at the first sector of the data portion of the disk, and the data station is placed in the selected mode.)

In summary, rekeying programs as they are used is inefficient and an error prone practice. Programs should be stored on a diskette in one of the following ways:

1. Create a separate program diskette that contains all programs routinely used for key entry, verification, and field totals operations.
2. Record the programs on the same diskette that is used for recording and verifying data.

Whichever procedure is adopted (shared diskettes or separate program diskettes) the programs must be identifiable for the operator. Three common methods can be used:

1. Put all program formats into a single data set. Identify each program data set with a header record.
2. Put each program data set (payroll, invoicing, etc.) into a separate data set, include header information in that data set's label.
3. Put all program formats in a single data set and record the exact address of the first program in each job's set. To call a program for loading, search to the address of the first program.

There are many advantages to separate program diskettes. The most important is that chances for accidental destruction of program formats are reduced by isolating program disks, labeling them externally with color codes, and building two-disk procedures into each job that is converted to the 3741.

Displaying Programs

The currently selected program can be displayed by pressing FUNCT SEL lower and DISPLAY PROG. The program replaces the data record displayed on the screen. Attempting to display program 0 results in the current record being displayed. DISPLAY DATA is used to restore the current data record to the display after a display program operation has been performed. For more information about displaying programs, see the *IBM 3741 Data Station Operator's Guide*, GA21-9131.

Changing a Program in a Program Buffer

A program in a program buffer can be changed during data entry. This is usually done when a program that has been placed in a program buffer is in error. For information on how to change a program that is in a program buffer, see *How to Change a Program that is in a Storage Area* in the *IBM 3741 Data Station Operator's Guide*, GA21-9131.

PROGRAM CHAINING

When records having different formats are being entered, different programs to control the format of the records are required. Program chaining provides the ability to automatically select programs when the format changes from one record to the next. Program chaining frees the operator from manually selecting a new program when the format of the record changes. Program chaining can be done in a forward (when record advancing) or backward (when record backspacing) manner.

Positions 127 and 128 of a program are used for chaining. Position 128 is used to indicate the program to select when a record advance operation occurs. Position 127 is used to indicate the program to select when a record backspace operation occurs. These positions have to be filled in only when record format changes and a different program is needed.

Any valid program number can be placed into positions 127 or 128 of the program. Acceptable characters for program chaining are numbers 0 through 9 and hex FA (corresponding to program buffer A) for the 3741.

Program chaining characters can be part of a programmed field. If the program chaining characters are part of a programmed field, they will be treated as numeric continuation characters when data is being entered but they will also perform the program chaining function.

If program chaining is used with field totals, there must be at least one field continuation character between the field definition character and the chaining characters. If this is not done, the chaining characters would be interpreted as defining a field totals field in addition to performing their chaining function. For example, if N12 were in positions 126, 127, and 128 a field totals field would be defined. The 3741 would interpret this to be a field totals field three position in length and the value in this field would be added to accumulators 1 and 2. The numbers 1 and 2 would also cause appropriate program chaining to occur. This would occur even though the intention was to have a single numeric field (N) and the numbers 1 and 2 were for chaining purposes only. Do not use program chaining characters as part of field totals fields in program levels used during offline field totals operations.

Program Chaining Example

The following is an example of program chaining.

Assume that a job is being entered with the program in program buffer 1 controlling the format of the data record. Program buffer 1 contains the following program:

A.....N.....R.....E → 3

Position 127 contains no chaining character, therefore, on record backspace, the program in program buffer 1 will continue to be used to control the format of the data record.

The 3 is in position 128. This means that after the data record has been entered and record advance occurs, the program in program buffer 3 is to be selected to control the format of the next data record.

Assume now that record advance has occurred and program buffer 3 is selected. Program buffer 3 contains the following program for controlling the format of the data record to be entered:

A.....S...N.....R.....D...E → 12

The 1 is in position 127. This means that if a record backspace occurs, the program in program buffer 1 is to be selected. (Program buffer 1 contains the program that was used to control the format of the record being backspaced to.

The 2 is in position 128. This means that after data has been entered and record advance occurs, the program in program buffer 2 is to be selected to control the format of the next data record.

Assume now that record advance has occurred and program buffer 2 is selected. Program buffer 2 contains the following program for controlling the format of the data record to be entered:

N.....A.....R.....D.....S.....V.....E → 3

The 3 is in position 127. This means that if a record backspace occurs, the program in program buffer 3 is to be selected. (Program buffer 3 contains the program that was used to control the format of the record being backspaced to.

Position 128 contains no chaining character, therefore, on record advance, the program in program buffer 2 will continue to be used to control the format of the data records.

OPERATOR GUIDANCE

Operator guidance can be used to assist the operator when keying records. On the 3741, operator guidance assists the operator by displaying information on the last 30 positions of lines 5 and 6. Line 5 can be used to display the current program field or a prompting message field. Line 6 displays the data entered into the current field up to the cursor position. Before data is keyed into the current field, line 6 contains slashes (/). The number of slashes is equal to the field length or a maximum of 30 slashes. As data is keyed, the character keyed replaces a slash and is also placed into the current field. Figure 15 shows the display with data and operator guidance lines.

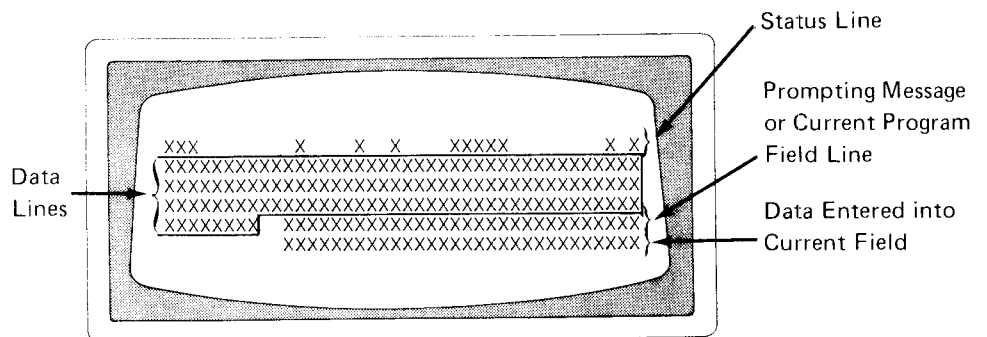

Figure 15. Display with Operator Guidance

Prompting Messages

A prompting message record consists of prompting message fields. A prompting record is directly related to a program. That is, for each field in the program, there must be a corresponding field in the prompting record. Each message field can be up to a maximum of 30 characters long. There can be a maximum of five prompting message records. Prompting message records must be stored in the even numbered program buffers 2, 4, 6, 8, and A. Each prompting record is associated with the program in the next lower numbered program buffer. This means that a prompting message record in program buffer 2 is associated with the program in program buffer 1 and so on.

Writing Prompting Message Records

Remember that for each field in a program, there must be a corresponding field in the prompting message record.

The first character of a prompting message record must be an asterisk (*). The asterisk is a delimiter and is not displayed. Follow the asterisk with the first field's prompting message. Follow the first field's prompting message with an asterisk. Continue entering subsequent prompting message fields following each field with an asterisk. Each prompting message field must be followed by an asterisk. A prompting message record is limited to 128 characters (the length of a program buffer). The asterisks count as one character.

If no prompting message for a field is desired, enter only an asterisk for the field. The asterisk is needed even though no prompting message is displayed in order to keep the prompting message fields in the prompting record in their corresponding relationship to the fields in the related program.

Loading Prompting Message Records

Once a prompting message record is entered into the current record buffer, it can be loaded into a program buffer. The program buffer into which the prompting message record is placed must be an even numbered program buffer (2, 4, 6, 8, A) and the program to which the prompting message record is related must be in the next lower numbered buffer. For example, if the prompting message record is loaded into program buffer number 4, the program to which the prompting message is related must be in program buffer 3.

When a program is selected for use, the prompting message record is also activated and the first prompting message field is displayed on line 5.

Example

Here is an example of a source document, its program, and a prompting message record that might be used.

	1 - 10	20 - 21	40 - 41	60 - 61	70 - 71	80
Source Document	Company Name	Address	City and State	Dup	Skip	
	Viking Stereo Co.	1122 20 St NW	Elba, Minn			
	Eau Galbe Cheese	1314 11 Ave SW	Eau Galbe, Wis			
	NCS, Inc.	2020 19 Ave SE	New York, NY			
Program	A.....N.....A.....D.....S.....E					
Prompting Message Record	*Company Name* Address* City and State* Dup* Skip*					
	Or if you didn't want a message for the dup and skip fields					
	Company Name Address* City and State***					

The program could be loaded into program buffer 5 and the prompting message record could be loaded into program buffer 6. When program buffer 5 is selected for use, the display would look like this:

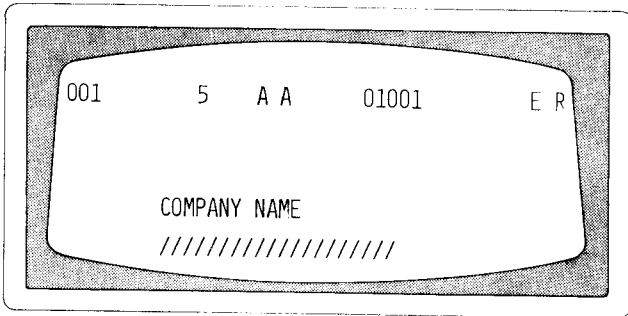

As the operator keys the name of the company, the display looks like this:

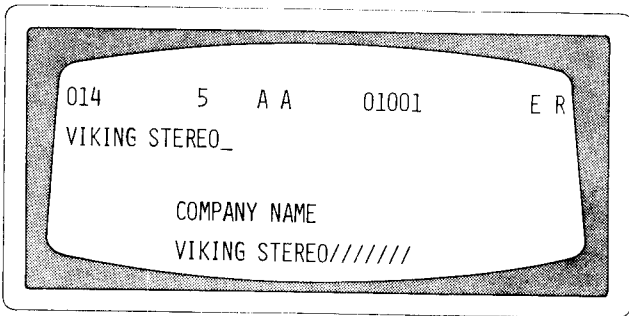

When the operator completes the company name field, the display would change to:

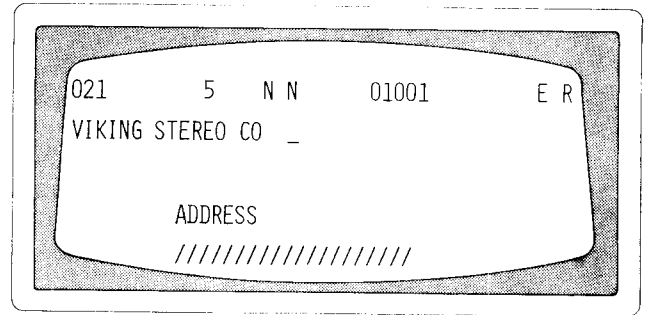

The operator would now key in the address of the company. This process will continue until the end of the record is reached. When record advance is pressed, the display changes and prompts for company name to start the next record.

When a program is selected, the related prompting message record is also activated. If it is desired to display the current program field instead of the current prompting message field, the DISPLAY FIELD PROG key can be used at any time to display the program field. After using the DISPLAY FIELD PROG key, the DISPLAY FIELD NAME key is used to return the machine back to displaying prompting messages.

Chapter 4. Production Statistics

Production statistics provide statistics on data production for use in measurement of workload, analysis of errors, and job accounting. The production statistics function provides three counters to accumulate totals on:

- Number of keystrokes.
- Number of records processed.
- Number of characters corrected during verify mode including all characters keyed in field correct mode.

COUNTERS

Keystroke Counter

The keystroke counter counts every keystroke, except the following, in all modes of operation.

1. RESET
2. Keystrokes with a pending error condition except dash (–) or ampersand (&) when used to reset a self-check error.
3. R key when used to restore the display after displaying production statistics or field totals.
4. Any keystroke during disk copy, offline field totals, or search.
5. Any function select keying sequence.

The keystroke counter does not normally count keystrokes that cause errors. However, the following are exceptions:

1. Miskeying hex data.
2. When keying characters other than 0 through 9 in a program numeric field with the program numeric switch set to NUMBERS ONLY. (Each non-numeric keystroke is counted.)

The keystroke counter is a six-position counter that can accumulate up to a total of 999,999. When 999,999 is reached, the counter is reset to 000,000. No overflow condition is indicated.

Record Counter

The record counter counts the number of records processed in the enter, update, and verify modes. Record advances in update mode are not counted unless data has been entered into the current record buffer. Record advances in verify mode are not counted if performed from the first manual position in the record. The record counter is a six-position counter that counts up to a maximum of 065,535. When the counter reaches 065,535, it is reset to 000,000. No overflow condition is indicated.

Note: If the operator backspaces and rekeys previous records, these records are recounted. Also, when a record is deleted the counter is not decremented. Therefore, the record count can exceed the number of records in the batch.

Verify Correction Keystroke Counter

The verify correction keystroke counter counts the number of characters corrected during verify mode or entered during field correct mode except when a sign is changed on a numeric right-adjust field or when a dash or ampersand is used to override a self-check error. The verify correction keystroke counter is a six-position counter that counts up to a maximum of 065,535. When the counter reaches 065,535, it is reset to 000,000. No overflow condition is indicated.

DISPLAYING PRODUCTION STATISTICS

Production statistic counters are in the first 21 positions with a blank between each counter as in the following display. The record count is displayed in positions 2-7, the keystroke count in positions 9-14, and the verify correction count in positions 16-21.

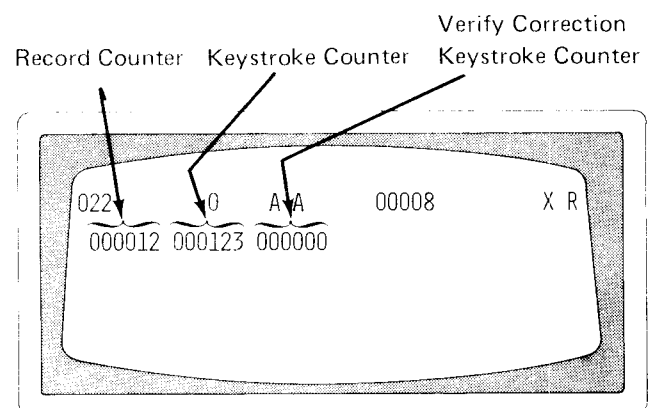

The production statistic counters can be displayed in read index mode or displayed and then written on disk in enter mode.

To display production statistic counters in read index mode, press FUNCT SEL lower and DISPLAY PROD STAT. After the counters are displayed, the data display can be restored by:

- Pressing RESET, which causes the data set label to be displayed. The production statistic counters are not reset to zero.
- Pressing R, which causes the data set label to be displayed and resets the counters to zero.

To display production statistic counters in enter mode, the following conditions must exist:

- Program 0 must be selected.
- The record length must be 21 positions or greater.
- No data has been entered into the current record buffer.
- No leading automatic duplicate/skip fields have been executed.

After the production statistic counters are displayed in enter mode, they can be written on disk by pressing REC ADV. Also, when the counters are displayed in enter mode, the cursor is positioned at position 22. This positioning allows additional data to be keyed beyond position 22 up to the record length, prior to pressing record advance.

The record is written on disk and the disk address is incremented by one when REC ADV is pressed. The production statistic counters are not reset to zero in enter mode. See the *IBM 3741 Data Station Operator's Guide*, GA21-9131, for a complete description on how to display production statistics counters in read index or enter mode.

TRACK TO RECORD CONVERSION TABLE

Figure 16 is a track to record conversion table. It is provided as a quick method for determining the number of records keyed. The conversion table is an accurate alternative to production statistics for obtaining a record count. The conversion table could also be used when a grand total is being maintained in the production statistics record counter and totals for individual batches are desired. The number of records keyed is shown for each track on the disk.

TRACK	NUMBER OF RECORDS	TRACK	NUMBER OF RECORDS
01	Number of sectors used on this track	36	910*
02	26*	37	936*
03	52*	38	962*
04	78*	39	988*
05	104*	40	1014*
06	130*	41	1040*
07	156*	42	1066*
08	182*	43	1092*
09	208*	44	1118*
10	234*	45	1144*
11	260*	46	1170*
12	286*	47	1196*
13	312*	48	1222*
14	338*	49	1248*
15	364*	50	1274*
16	390*	51	1300*
17	416*	52	1326*
18	442*	53	1352*
19	468*	54	1378*
20	494*	55	1404*
21	520*	56	1430*
22	546*	57	1456*
23	572*	58	1482*
24	598*	59	1508*
25	624*	60	1534*
26	650*	61	1560*
27	676*	62	1586*
28	702*	63	1612*
29	728*	64	1638*
30	754*	65	1664*
31	780*	66	1690*
32	806*	67	1716*
33	832*	68	1742*
34	858*	69	1768*
35	884*	70	1794*
		71	1820*
		72	1846*
		73	1872*

* Add the number of sectors used on this track to this number to get the total number of records

Figure 16. Track to Record Conversion

Note: The conversion table assumes there are no deleted records on a track. If there are deleted records, subtract the number of deleted records from the total.

The EOD address in the data set label can also be used to determine the number of records in a data set. However, remember that the EOD address is one more than the actual number of records in the data set.

Chapter 5. Online Field Totals

Field totals can be used for batch auditing, a process sometimes referred to as "hash totals", or for other applications where totals are required, such as summing the prices of individual items on an invoice to obtain the total order cost. Two or more fields within a record can be added and read out into a summary field in the same record or a following record (crossfooting).

Field totals can be done (1) online on the 3741 during the process of entering, updating, or verifying records, or (2) offline, in a separate scan of a batch of records.

ONLINE FIELD TOTALS OPERATION

Three 19-digit accumulators are provided with this feature. Data can be algebraically summed in these accumulators from specified fields in any or all records in a batch. The summation is under control of the program; the program specifies that a field is to be summed and in which of the three accumulators the sum will be placed. Field total fields are identified by following a field definition character with a 1, 2, or 3 which specifies which of the three accumulators is to be used. The second and third positions after the field definition character may be used to cause the field to be accumulated in two or three accumulators. The length of the fields used is based on the number of accumulators that will be used. The minimum field length for one accumulator is 2 positions, 3 positions for 2 accumulators, and 4 positions for 3 accumulators. The low-order 14 digits of a field total field are added into a specified accumulator. If overflow beyond 19 digits occurs in an accumulator, it will not be indicated.

In addition to the numbers 0 through 9, a field total field may include any of the 256 EBCDIC codes. All codes with the low-order four bits of the codes equal to 0 through 9 accumulate with numeric values 0 through 9. All other codes accumulate with a numeric value of zero. All fields in which the units position codes have the high-order four bits equal to B or D are considered negative. All other fields are considered positive.

In online field totals, the accumulators are reset to zero only when the power is turned on, when a reset is accomplished by pressing the R key with field totals displayed, or when entering a field in a record that is programmed as a read out and reset field. A good practice is to display field totals and reset the accumulators before starting an online field totals operation.

During an online field totals operation, the amount that is added to an accumulator in a given field is equal to the change that occurs in that field from the time the cursor comes into the field until the cursor leaves the field. In enter mode, when the cursor comes into a field, the field is always blank and its numeric value is zero; therefore, the amount added to the accumulator is equal to the amount entered. In update or verify mode, the amount added is zero unless the field is modified, and, if so, the amount added is the algebraic difference obtained by subtracting the initial amount of the field from the final amount of the field.

The accumulators represent the field totals operations up to the most advanced record written on disk and any operations on the current record being processed. When deleting a record or backspacing to a previous record from a partially entered, updated, or verify-corrected record, all accumulated fields are algebraically subtracted from the specified accumulators. When record backspacing from completed records, no subtraction of accumulator fields occurs as they are backspaced over.

Displaying Field Totals

Field totals accumulators can be displayed when the cursor is at the beginning of a field by pressing DISPLAY FIELD TOTALS. Any data currently being displayed is removed from the screen, and the amounts currently residing in the accumulators are displayed. At this point the system accepts only two keys, RESET and R. Pressing R removes the field totals display, displays the data set label, and resets all accumulators to zero. Pressing RESET removes the field totals display and displays the record, but does not reset the accumulators.

PROGRAMMING ONLINE FIELD TOTAL FIELDS

The following describes how to program the field total fields for online field totals when you are writing programs to be used by the operator.

Accumulate Totals Fields

To indicate which fields in a data record are to be accumulated into a field totals accumulator, follow any field definition character in a program by a 1, 2, or 3. Following a field definition character by a 1 means the field in the data record will be accumulated into accumulator 1. A field definition character followed by a 2 or 3 means the field in the data record will be accumulated into accumulator 2 or 3 respectively. Figure 17 is an example of a program containing field totals fields that will be accumulated.

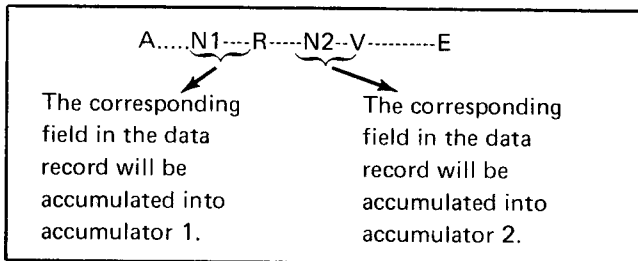

Figure 17. Example of a Program Containing Field Total Fields

A field may be accumulated into more than one field totals accumulator by following any field definition character by more than one number. For example, if a program contains N12---field, this means that the corresponding field in the data record would be accumulated into accumulators 1 and 2.

In enter mode, the amount added into an accumulator is equal to the amount entered in the field of the record. In update or verify mode, the amount added to an accumulator is zero unless the field in the record is modified, and, if modified, the amount added to the accumulator is the algebraic difference between the initial amount of the field and the final amount of the field.

Read Out/Reset Field Total Fields

Read Out/Reset field totals fields allows the accumulators to be read into a specified field in a data record and then the accumulators are reset to zero. To indicate a read out/reset field in a program, follow the bypass field definition character B, by a 7, 8, or 9. The 7 means to read out and reset accumulator 1, the 8 means to read out and reset accumulator 2 and the 9 means to read out and reset accumulator 3. There must be at least one manual field preceding any read out/reset field. Figure 18 shows an example of a Read Out/Reset field in a program.

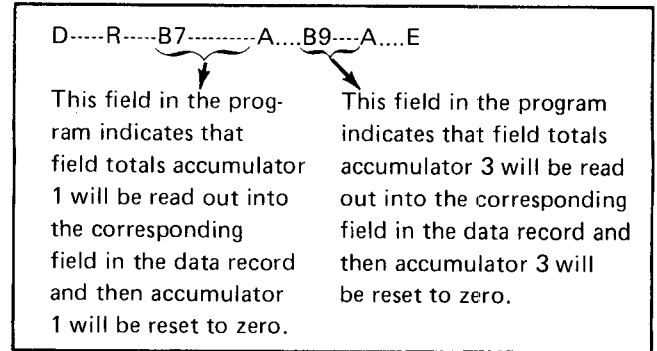

Figure 18. Example of Read Out/Reset Field in a Program

Not all of the accumulators have to be read out and reset when performing a field totals read out/reset operation. You can select which accumulators are to be read out and reset. If desired, each accumulator can be read out and reset at a different time during a field totals operation.

When records with field totals are changed in update or verify mode that will affect the accumulated totals for the subsequent Read Out/Reset field, it is required that a minimum of one character be changed or inserted into the record that contains the Read Out/Reset fields. This can be done by setting up a program with a one position field designed specifically to allow inserting of a character into the record, or by actually changing a character in the record.

Note: If the record containing the updated Read Out/Reset field does not have to be written to disk, the following procedures do not have to be followed.

For update mode, rekeying an existing character or keying a new character is considered a change to the record containing the Read Out/Reset field. However, if a program was set up with a field designed to allow insertion of a character into the record, the operator can key any desired character into that field.

For verify mode, the operator can position the cursor at the one character field that was programmed to allow insertion of a character into the record containing the Read Out/Reset field, select field correct mode, and key any character desired. Once the operator has pressed a data key, the 3741 goes back into verify mode and the operator must press the same data key that was pressed in field correct mode. If a program cannot be set up that allows insertion of a character into the record, the operator should select the shortest field in the record and perform a field correct operation on the field.

Online Field Total Restrictions

To ensure the accuracy of the field total in the accumulator, remember the following restrictions:

- Use only one program to process a record.
- When backspacing to a previous record from a partially entered, updated, or verified record, select the program used for the previous record only after the backspace to the previous record is complete.
- Before deleting a record, be sure the program used to create the record is selected.
- A read out/reset field must be preceded by at least one programmed manual field and must not be followed within the same record by a field totals field relating to that accumulator.
- Do not backspace to a record and select a program with a read out/reset field if the accumulator that pertains to that read out/reset has a value other than zero. The accumulator will have a value other than zero if any record was written on the disk with a field totals program for that accumulator and data was entered in that field in enter mode or changed in update or verify mode.
- After updating a record, deleting a record, or correcting a record in the verify mode, all succeeding read out/reset fields that were affected by the operation must be executed. To execute this field total operation, record advance to the record that contains the read out/reset field, select the correct program buffer, and field advance over the read out/reset field.
- In update mode or when E-R (alternate record advance option in enter mode) is selected, a read out/reset field is not executed if REC ADV is pressed before the cursor enters that field. Therefore, advance the cursor through all read out/reset fields before pressing REC ADV.
- When field totals are being used in a data set, do not use communications, second disk (except if loading programs), or printer functions (except print record) at any time during online field totals operations.

- Program load functions should be done as follows:
 1. Turn off AUTO DUP/SKIP.
 2. Press REC BKSP to the previous record.
 3. Select program buffer 0.
 4. Read program from second disk or key program.
 5. Load the program.
 6. Repeat 4 and 5 for all programs to be loaded.
 7. Press REC BKSP.
 8. Press REC ADV twice.

Note: Steps 7 and 8 are done to load the previous buffer with the correct record.

 9. Select desired program.

- When in a record with the wrong program selected, perform the following:
 1. Set AUTO DUP/SKIP to OFF.
 2. Record backspace to the previous record.
 3. Select correct program.
 4. Press REC ADV.
 5. Set AUTO DUP/SKIP to ON if required.

Example

The transactions for one day of business are:

Item Number	Item Cost
31621	1621
10897	734
41621	1621
10021	121
21100	1100
Total Cost	5197

Each transaction record contains the item number and item cost. Each item sold is considered one transaction. After the transaction records are entered, the operator must determine if any of the transactions were skipped during the entering process. To do this the cost field must be precomputed, and programmed as a field totals field, and the total cost from the accumulator must be read into a summary record. Then the field totals total can be compared with the precomputed total cost. If the totals are equal, all the transactions were entered. If the totals are not equal, the larger total can be subtracted from the smaller total to determine which transaction was skipped or duplicated. For example, if the field totals total is 4463, subtracting 4463 from 5197 gives 734 which indicates that the transaction for item number 10897, cost 734, was not entered on the disk.

To use the cost as a field totals field to be accumulated in accumulator 2, use the following program:

```
N----R2-----E
```

To read accumulator 2 into the summary record and reset the accumulator to zero, use the following program for the summary record:

```
N----B8-----E
```

Auto Balance Example

The online field totals feature can be used to find errors when an accumulated total does not match a precomputed balance sheet total. Errors in the records can be found by using online field totals in update or verify mode. In verify or update mode, only differences between the old value of the field and the new value are accumulated into the accumulators.

For example, assume an offline field totals operation was performed to accumulate a total on the total cost of items ordered. When the offline field totals operation is complete, the field totals total can be displayed and compared with a precomputed total on a balance sheet. Assuming that the field totals total and the precomputed total do not match, online field totals could be used in update (or verify) mode to find the record(s) in error (or missing) and make appropriate corrections to the records. Online field totals in update or verify mode accumulates only the difference between the old value of the field and the new value of the field. Therefore, after the operator changes some records, the accumulators could be displayed to see if the difference between the totals has been accounted for. If not, the operator would continue until the difference was accounted for.

Chapter 6. Offline Field Totals

Field totals can be used for batch auditing, to obtain what is sometimes referred to as hash totals, or for other applications where totals are required, such as summing the prices of individual items on an invoice to obtain the total order cost.

The offline field totals feature is used to obtain totals from records that have already been entered, updated, or verified. The offline field totals feature uses three 19-digit accumulators to add, under program control, data in specified fields into the assigned accumulator. A field total may include any number, 0 through 9, and any one of the 256 EBCDIC characters. All codes with low-order four bits equal to 0 through 9 are added with a value of 0 through 9. All other codes have the value of 0. All fields having units position codes with the high-order four bits equal to a B or D are negative fields.

The offline field totals feature allows you to:

- Accumulate totals.
- Read field totals from an accumulator into a record without resetting the accumulator.
- Read field totals from an accumulator into a record and reset the accumulator to zero.

OFFLINE FIELD TOTALS OPERATION

The offline field totals feature can be selected from the read index or update mode. When this feature is selected, the mode changes to field totals and an F is displayed in the status line. See the *IBM 3741 Data Station Operator's Guide*, GA21-9131, for information on field totals operating procedures.

Offline field totals require programs and control statements. Programs define what field totals operations are to be performed and control statements identify which records are to be processed and which program is to be used to process each record. A description of how to prepare programs and control statements for field totals operations is provided later in this chapter.

When the field totals operation is initiated, the accumulators are reset to zero. Records are processed under control of a program specified by a control statement that was satisfied. Field definition characters, except those followed by a number, are ignored. Field totals fields are identified by following a field definition character with a number (1 through 9) which specifies which of the accumulators are involved in the field totals operation.

The low-order 14 digits of a field totals field are added into the specified accumulators. Deleted records are bypassed in a field totals operation. Disk errors and invalid control statement errors stop the field totals operation.

If AUTO REC ADV is turned off during a field totals operation, the field totals operation stops, and the record following the last record processed is displayed. Press REC ADV to process the record displayed and advance to the next record. Pressing RESET during a field totals operation changes the mode to update mode and terminates the field totals operation.

At the end of a field total operation, the accumulators retain the accumulated field totals unless a read out and reset was the last operation performed. If the end-of-data address is reached, the data set label is displayed, and the mode changes to read index mode.

Displaying Offline Field Total Accumulators

The contents of the field total accumulators and their sign can be displayed any time during the field total operation. For the 3741, the cursor must be at the start of a field and not at the end of record condition. For information on how to display the accumulators during a field totals operation, see the *IBM 3741 Data Station Operator's Guide*, GA21-9131. Figure 19 shows the field totals display.

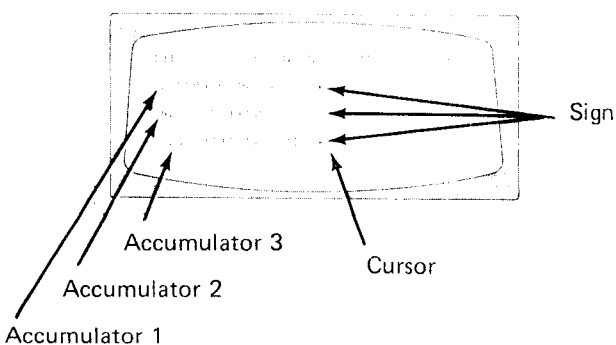

Figure 19. Field Totals Display

PROGRAMMING OFFLINE FIELD TOTAL FIELDS

The following describes how to program the field totals fields when you are writing programs to be used by the operator.

Accumulate Totals Fields

To indicate which fields in a data record are to be accumulated into a field totals accumulator, use any field definition character in a program followed by a 1, 2, or 3. A field definition character followed by a 1 means the contents of that field in the data records will be accumulated into accumulator 1. A field definition character followed by a 2 or 3 means the contents of that field in the data records will be accumulated into accumulator 2 or 3 respectively. Figure 20 is an example of a program containing field totals fields that will be accumulated.

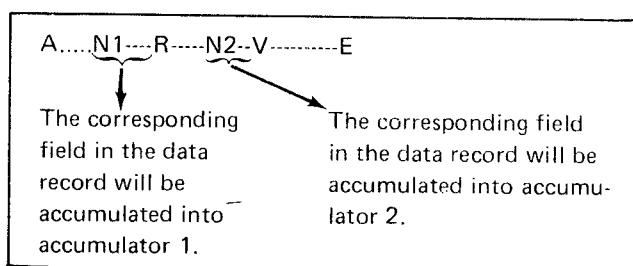

Figure 20. Example of a Program Containing Field Totals Fields

A field may be accumulated into more than one field totals accumulator by using any field definition character followed by more than one number. For example, if a program contains a N12-- field, the corresponding field in the data record is accumulated in accumulators 1 and 2.

Read Out Field Totals Fields

The field totals accumulations can be read out and placed into a data record without resetting the accumulators to zero. To indicate a read out field in a program, use the bypass field definition character, B, followed by a 4, 5, or 6. The 4 means read out accumulator 1 into the field in the record, 5 means read out accumulator 2 into the field in the record, and 6 means read out accumulator 3 into the field in the record. Figure 21 shows an example of a read out field in a program.

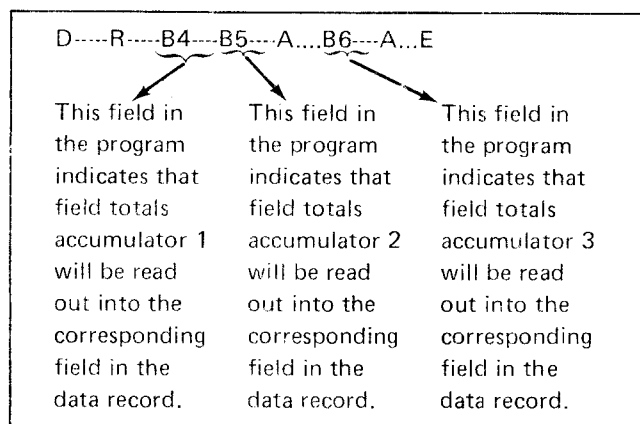

Figure 21. Example of a Read Out Field in a Program

Not all of the accumulators have to be read out when performing a field totals read out operation. You can select the accumulators to be read out. If desired, each accumulator can be read out at a different point during a field totals operation.

Read Out/Reset Field Totals Fields

Read out/reset field totals field allows the accumulators to be read into a specified field in a data record and then the accumulators are reset to zero. To indicate a read out/reset field in a program, use the bypass field definition character, B, followed by a 7, 8, or 9. The 7 means read out and reset accumulator 1, the 8 means read out and reset accumulator 2, and the 9 means read out and reset accumulator 3. Figure 22 shows an example of a read out/reset field in a program.

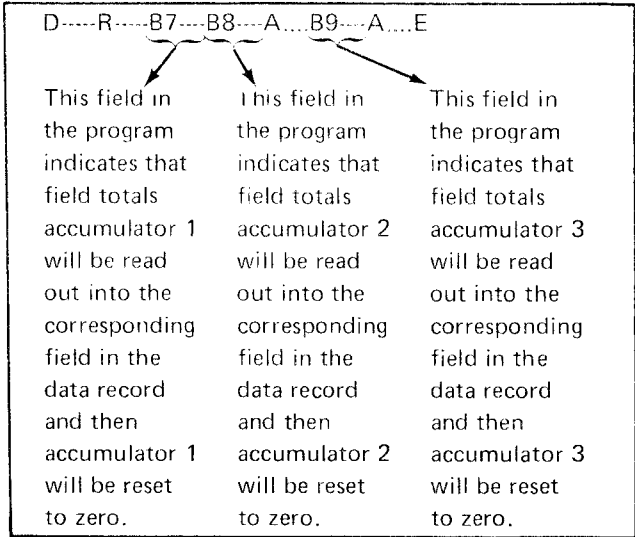

Figure 22. Example of a Read Out/Reset Field in a Program

Not all of the accumulators have to be read out and reset when performing a field totals read out/reset operation. You can select accumulators to be read out and reset. If desired, each accumulator can be read out and reset at a different point during a field totals operation.

CONTROL STATEMENTS

Offline field totals require a control statement as part of the field totals operation. A control statement, when satisfied, causes a particular program to be selected for processing the record. A control statement:

- Must start with a < character (this is the only means by which the field totals program can identify a control statement).
- May be continued in a consecutive or higher numbered buffer.

- Identifies which positions in the current record are to be compared against the compare characters.
- Identifies what character must be at a position being compared, what character should not be at a position being compared, or some combination of both conditions in order for the control statement to be satisfied.
- Must not be loaded into any program buffer that will be selected when a control statement is satisfied.
- Identifies the program to use when the control statement is satisfied. The selected program identifies:
 - The fields in the current record that are to be accumulated and into which accumulator the contents of each field must be accumulated.
 - The fields in the current record that an accumulated value will be read into (if indicated by the program).
 - The fields in the current record that an accumulated value will be read into and then the accumulator reset to zero (if indicated by the program).

Figure 23 identifies the control statement format characters.

Character	Meaning
<	This character identifies the program as a field totals control statement and must be in the first position of every program buffer used for control statements.
f	The f stands for any character 1 through 9 or A on the 3741. The character indicates which program is to be selected if this control statement is satisfied.
ccc	ccc stands for a 3-digit position number indicating the position in the data record that is to be compared with the compare characters. (001-128) 3741
W or N	W indicates that the position in the record must contain the character used in the control statement in order for the search to be satisfied. N indicates that the record position must not have the compare character.
m	m stands for the character with which the record position is to be compared. A comma (,) must separate compare characters. The comma (,) is used to separate compare characters (m).
&	The & is used in a control statement to perform logical AND functions. The AND function allows you to indicate that two or more positions in the record must match the compare characters before the record is processed.
;	More than one control statement can be in a program buffer. The ; must be used to separate control statements.
:	Field total control statements can be continued to a higher numbered buffer. To indicate that a control statement is continued in a higher numbered buffer, use the : after the last position of the control statement in the current program buffer. The period (.) indicates the end of the control statements. Place the period after the last control statement.

Control Statement Format Character Description

The following paragraphs will discuss each of the control statement characters and also build an example of field control statements.

Note: In the following descriptions, the lower case characters are a representation of entries you must make. The upper case characters are the exact character to be used.

< (Less Than Sign)

The less than sign (<) identifies a statement in a program buffer as being a field totals control statement. The less than sign must be in the first position of *every* program buffer that contains a field totals control statement.

<

f (Program Buffer to be Selected)

The **f** stands for the program buffer number that is to be selected if the control statement is satisfied. For the 3741, **f** can be 1 through 9 and hex A.

< f

ccc (Three Digit Position Number)

The **ccc** stands for a three digit position number that indicates the position in the data record that is compared with the compare character(s). Valid entries for the **ccc** field are 001 through 128 for the 3741.

< fccc

Figure 23. Control Statement Format Characters

W or N Field

This field is used to indicate whether a character should be present or absent in the position specified by **ccc**. The **W** indicates that the position in the record specified by **ccc** must contain the character **m** specified in the control statement in order for the control statement to be satisfied. The **N** indicates that the position in the record specified by **ccc** must not contain the character **m** specified in the control statement, in order to satisfy the control statement. The **W** or **N** must follow the position number **ccc**.

< fcccW

< fcccN

m Field

The **m** field stands for the character with which the record position specified by **ccc** is to be compared. The **m** can be any character **A** through **Z**, **0** through **9**, or a special character. The character, **m**, is called the compare character. The compare character must follow the **W** or **N** field.

< fcccWm

< fcccNm

A position in a record can be compared against more than one character. However, each compare character **m** in the control statement must be separated by a comma (,).

<fcccWm,m,m

The position being checked must have one of the characters specified by **m** in order to satisfy the control statement.

<fcccNm,m,m

The position being checked must not have any of the characters specified by **m**, in order to satisfy the control statement.

. (period)—End of Control Statement

The period (.) indicates the end of the control statement. If there is more than one control statement, the period must be at the end of the last statement.

< fcccWm.

< fcccNm.

;(semicolon)—Multiple Control Statement Separator

The semicolon is used when there is more than one control statement in a program buffer. The semicolon must follow each control statement except the last control statement which must have a period (.). When there are multiple control statements, each control statement is compared against the current data record until one of the control statements is satisfied. If none are satisfied, the next record is read.

<fcccWm;fcccNm.

<fcccWm,m,m;fcccWm;fcccNm,m.

Note: When coding multiple control statements, place the control statement that will be satisfied most often first. This will save time in running field totals operations.

: (colon)—Control Statement Continued in a Higher Numbered Buffer

Control statements can be continued into another higher numbered buffer. When a control statement is continued in a higher numbered buffer, place a colon (:) after the last character in the current program buffer. The colon (:) can be placed after any character desired.

Program buffer 2

<fcccWm,m,m;:

Control statement continued character

The less than sign must be in the first position of the buffers.

Program buffer 3

<fcccWm.

When a control statement will be continued in a higher numbered buffer, it does not have to be in the next consecutive higher numbered buffer. The statement has only to be continued in a higher numbered buffer.



Note: If the compare character *m* is a colon (:), it is treated as a compare character. Therefore, if *m* is a colon (:), and the control statement will be continued in a higher numbered buffer, another colon is needed.

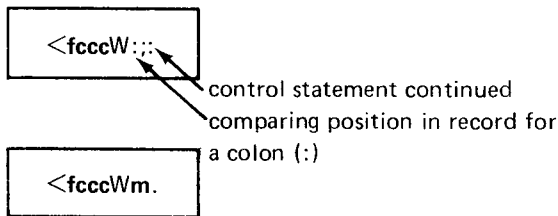

& (ampersand) Logical AND

The & (ampersand) can be used in a control statement to perform a logical AND function. This means that more than one position in a record can be compared against the control statement.

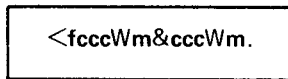

Example: `<1010WA&020W4.` This control statement is satisfied if position 10 of the record has an A AND position 20 has a 4. Program buffer 1 will be selected to process the record if the control statement is satisfied.

Examples

The following are examples using all of the control statement format characters that are available.

Example 1: `<2002WA,B.`

- Period must be at the end of the control statement.
- Comma must separate compare characters.
- Less than sign must be in the first position of each program buffer that contains a control statement.

This control statement will be satisfied if the current data record has an A or B in position 2. Program buffer 2 will be selected if the statement is satisfied.

Example 2: `<2002WA,B;1010NV.`

Control statement separator

This is a multiple control statement. The field totals program will first check to see if the data record has an A or B in position 2. If there is an A or B in position 2, the control statement is satisfied and program buffer 2 will be selected to process the record. If the first control statement `2002WA,B` is not satisfied, the field totals program goes to the next control statement (`1010NV`) to see if it can be satisfied. This control statement is satisfied if position 10 of the data record does not have a V. Program buffer 1 is selected for processing the data record if this statement is satisfied. If neither statement is satisfied, the next data record is read.

Example 3:

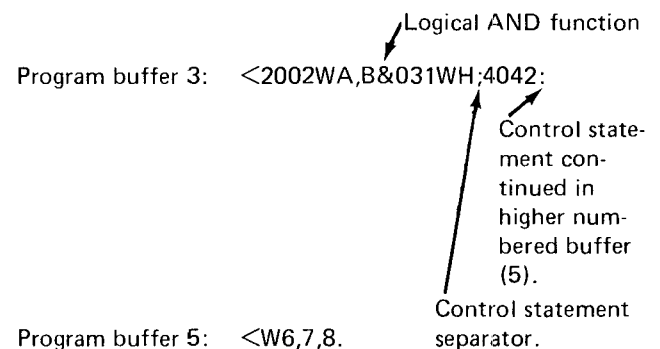

This is a multiple control statement that is continued in a higher numbered buffer. The first control statement (`2002WA,B&031WH`) contains a logical AND function. The control statement `2002WA,B&031WH` is satisfied if position 2 of the data record has an A or B AND position 31 has an H. Program buffer 2 is selected to process the data record if the statement is satisfied. If this control statement is not satisfied, the next control statement (`4042W6,7,8`) will be used. Note that this control statement is continued in a higher numbered buffer. This control statement is satisfied if position 42 of the data record has a 6, 7, or 8. Program buffer 4 is selected for processing the data record if the statement is satisfied. If neither statement is satisfied, the next data record is read.

Unconditional Program Buffer Selection

If only one program is required to process records in the field totals operation, a control statement can be written that will unconditionally select the desired program buffer. The general control statement is as follows:

```
<f.
```

where f is the is the desired program buffer number 1 through 9 and A.

Offline Field Totals Example

An offline field totals operation is to be performed on a data set that contains several different kinds of records. The field totals operation to be performed depends upon the content of the records.

Figure 24 shows the field totals operation to be performed for each record type. If the record type indicated by the first column in the figure contains the data indicated by the second column, the operation in the third column needs to be performed.

Depending upon the type of record, one of four different types of field total operations are performed:

1. Add a field to both accumulators 1 and 2.
2. Add the field to accumulator 2 only.
3. Read the contents of accumulator 1 into the current record buffer and reset the accumulator.
4. Add the field to accumulator 3.

Four different programs are required to do these operations. This example used program buffers 1-4 for these programs. Program buffer 1 contains the program to add the field in positions 30-35 of the data record into accumulators 1 and 2. To program a field as a field totals field, use any field definition followed by 1, 2, or 3 to indicate the accumulator. All field definition characters in the program except those used by field totals fields are ignored.

In this example all fields except the field totals field are programmed as bypass fields. The program in program buffer 1 is:

```
B-----N12---E
                    Field totals field
                    in positions 30-35
```

Program buffer 2 contains the program to add the field in positions 30-35 of the data record into accumulator 2. The program in program buffer 2 is:

```
B-----N2----E
                    Field totals field
                    in positions 30-35
```

Type of Data Record	Contents	Desired Operation
1	A in position 10 and B or C in position 25	Add the field in positions 30-35 of the record to accumulators 1 and 2.
2	Numbers in position 50	Add the field in positions 30-35 of the record to accumulator 2.
3	Blanks in positions 50 through 55	Read the contents of accumulator 1 into the record in positions 1-10 and reset accumulator 1.
4	All records that do not satisfy the conditions of the other 3 types of records	Add the field in positions 30-35 of the record to accumulator 3.

Figure 24. Field Total Operations

Program buffer 3 contains the program for the record that accumulator 1 is to be read into. The accumulator is read into positions 1 through 10 of the record. The program also causes accumulator 1 to be reset to zero. The program in program buffer 3 is:

B7-----E

Field that accumulator 1 is read into

Program buffer 4 contains the program to add the field in positions 30-35 of the record in accumulator 3 if the conditions to use the programs in program buffers 1 through 3 are not satisfied. The program in program buffer 4 is:

B-----N3-----E

Field totals field
in positions 30-35

To cause the program that is to process each record type to be selected automatically, write control statements. Each control statement indicates the conditions that must be satisfied before a program is selected. The control statements for this example begin in program buffer 5. Each control statement is separated by a semicolon. The colon is used at the end of program buffers 5 and 6 to indicate that the control statements are continued in a higher program buffer. The control statements follow:

Program Buffer 5

<1010WA&025WB,C

Selects program buffer 1 if position 10 contains an A and position 25 contains a B or a C.

;2050W0,1,2,3:

Selects program buffer 2 if position 50 is numeric. This control statement is continued in program buffer 6.

Program Buffer 6

<,4,5,6,7,8,9;3050Wb&051Wb&052Wb&053Wb&:

Continued from program buffer 5

Selects program buffer 3 if positions 50-55 are blank. (The *b* represents a blank space.) This control statement is continued in program buffer 7.

Program Buffer 7

<054Wb&055Wb;4.

Continued from program buffer 6

Selects program buffer 4 if another program level has not been selected.

Offline Field Totals Setup Example

The following is an example of an easy way to write control statements when different programs are used for entering data.

When writing programs required for a job that has field total fields, set aside one position in the program for keying the program number used when keying data for the record. This one position field will assist you in writing the offline field totals control statements required to process records in the data set.

For example, assume programs with field totals fields have been written and are in program buffers 1, 2, and 3. Also, assume that position 20 in the program represents the position in the data record into which the program number being used to control the format of the record will be keyed. Also assume that enter mode has been selected and data can now be keyed. The first data record requires program number 1.

Record 1

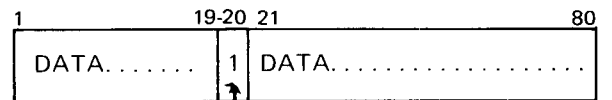

A one is keyed into this position (20) to indicate that program number 1 was used to control the format of this data record.

The second data record requires program number 2.

Record 2

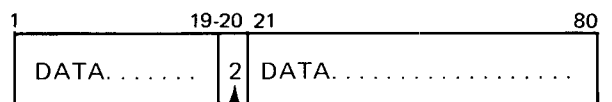

A two is keyed into this position (20) to indicate that program number 2 was used to control the format of this data record.

The third record requires program number 3.

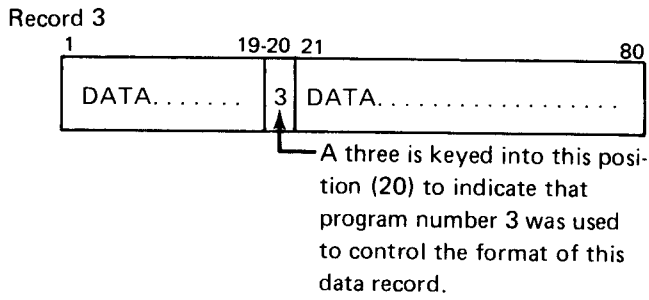

This process continues until all data records have been keyed. Position 20 in the data record identifies the program that was used to control the format of each record.

After all data has been keyed, assume that an offline field totals operation will be performed. Since each record in the data set has a position 20 that identifies the program under which data was keyed for the record, this information can be used in writing control statements required to process the job in offline field totals mode.

The control statement would be:

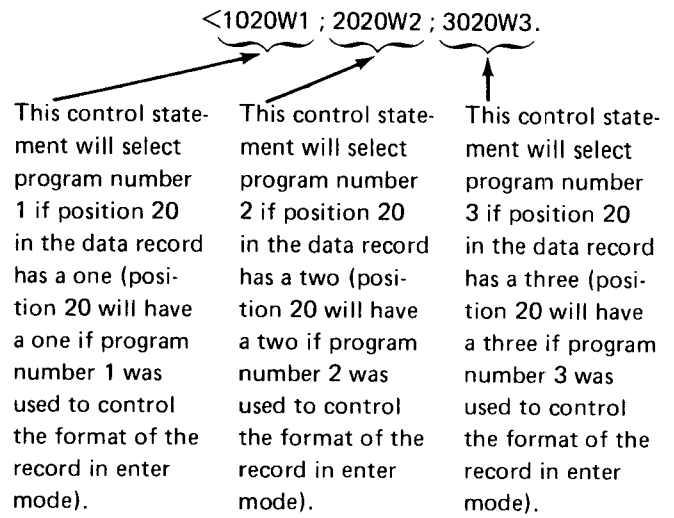

If the preceding technique can be implemented, it will assist you in using offline field totals mode.

Dual disk capability is obtained on the 3741 by means of an additional disk drive provided by the second disk feature. The second disk unit is to the left of the first disk unit.

The purpose of second disk operations is to permit the following:

1. Duplicating a disk in order to have more than one copy or to save data from a disk that has developed a defect.
2. Merging records from a disk with records from the keyboard.
3. Pooling the data from several disks onto one disk.
4. Extended program storage; programs can be loaded into the program storage buffers from the second disk without removing the disk 1 disk.
5. Expanded storage for use with the communications feature.

DUAL DISK OPERATION ON THE 3741

After insertion of a disk in the second disk drive, the first of any of the following operations activates disk 2, positions disk 2 at track 00, sector 08, and displays the sector 08 label.

- Disk 2 record advance
- Disk 2 record backspace
- Disk 2 return to index

The address of disk 2 is displayed at the righthand end of the status line in positions 31 through 35. The address is posted or changed only when disk 2 operations are performed. Insertion and removal of disk 2 are not monitored by the machine and therefore inserting a disk does not post a disk 2 address or remove an existing disk 2 address; likewise, removing disk 2 does not cause the existing disk 2

address to be removed from the display. Keying FUNCT SEL lower and the A key will remove the existing disk 2 address.

Disk 2 is read but not written on except in the communications mode. Disk 2 is controlled by the following keys:

- Disk 2 record advance
- Disk 2 record backspace
- Disk 2 return to index
- Copy
- Search content
- Search sequential content
- Search address

SEARCH OPERATIONS ON THE SECOND DISK

The following procedures are used to search on disk 2:

1. Press FUNCT SEL lower.
2. Hold down NUM SHIFT and press SEARCH CONTENT, SEARCH SEQ CONTENT, or SEARCH ADDRESS.
3. Key the search mask or address.
4. Press FUNCT SEL upper and DISK 2 REC ADV.

After the first content search, subsequent searches by content using the same search mask can be accomplished as follows:

1. Press FUNCT SEL upper and DISK 2 REC ADV.
2. Press FUNCT SEL lower, hold down NUM SHIFT, and press SEARCH CONTENT.
3. Press FUNCT SEL upper and DISK 2 REC ADV.

COPY

The copy function provides:

- Copying all or part of disk 2
- Copying all or part of a data set
- Copying up to a specified record on disk 2
- Copying a record

Copying is always done from disk 2 to disk 1.

Copy All (Image Copy) or Part of Disk 2

This copy function copies disk 2 onto disk 1, beginning with the sector in track 00 where disk 1 is positioned. The last record is copied from the sector located at the end of extent (EOE) of the label at which disk 2 is positioned at the start of the copy function.

Each record is copied into the corresponding track and sector address; that is, the record from track 02, sector 14 of disk 2 will be copied into track 02, sector 14 of disk 1. All records will be copied regardless of content, including deleted records, records outside of defined extents, and normal data records between the beginning of extent (BOE) and the end of data (EOD).

Notes:

1. During a copy all or part of disk 2 operation, program buffers 1 through 8 are destroyed and should be restored after the copying is complete.
2. The write protect status is not checked and does not protect against copying onto the disk.

For operating procedures on copying all or part of disk 2, see the *IBM 3741 Data Station Operator's Guide*, GA21-9131.

Copy All (Image Copy) or Part of a Data Set

The primary purpose of this function is to pool data from two or more disks onto one disk by adding data from disk 2 to the end of the data already recorded on disk 1. A sequence of such copies can involve loading several disks into the disk 2 drive and pooling the work of several operators onto one disk. Deleted records are not copied.

For operating procedures on copying all or part of a data set, see *IBM 3741 Data Station Operator's Guide*, GA21-9131.

Copy Up to a Specified Record on Disk 2

This function can be used to merge records from disk 2 with records that are keyed from the keyboard. It can be used to insert missing records or add records to a data set. All records except deleted records are copied up to, but not including, the specified record. At the end of the copy function, the specified record is displayed.

For operating procedures on copying up to a specified record on disk 2, see *IBM 3741 Data Station Operator's Guide*, GA21-9131.

Copying a Record

This function allows you to copy one record at a time by performing a search disk 2 operation, or by pressing DISK 2 REC BKSP or DISK 2 REC ADV, whichever is necessary to find the record you want to copy. The record to be copied is on disk 2. This copy function can be done in enter, update, or read index mode. If you are in enter mode after the record from disk 2 has been displayed, the record can be entered onto disk 1 by pressing REC ADV. If you are in update mode after a record from disk 2 has been displayed, the first character of the record must be rekeyed and then REC ADV pressed. If you are in read index mode, press FUNCT SEL lower, M, and REC ADV to enter the record onto disk 1.

All disks are initialized before they are shipped to a customer. Reinitializing should be avoided unless necessary; it is required only if:

1. The disk was exposed to a strong magnetic field.
2. A defect occurred in one or two tracks. In this case, initialization can be used to take the bad track(s) out of service and add one or two tracks from the spare area.
3. A sector sequence other than the sequence existing on the disk is desired. See *Initialization Procedures* in this chapter for information on how to specify the desired sector sequence.

Note: It is not necessary to reinitialize when a diskette is to be reused.

The purpose of initialization is:

1. To write identification fields, one for each sector in all active tracks on a disk.
2. To write the bad track code in defective tracks. The maximum permissible number of bad tracks is two.
3. To write a record in each sector of each active track. All records are filled with the blank character except in track 00.
4. To write 80-character records in track 00.

After the index track is written, sectors 1 through 4 and 6 contain 80 blanks each. Sector 5 contains ERMAP followed by 75 blank characters. If one or two bad tracks were specified, the number of the first bad track will be in positions 7 and 8 of sector 5 with a zero in position 9, the number of the second bad track will be in positions 11 and 12 of sector 5 with a zero in position 13. Sector 7 contains VOL1 in positions 1 through 4, the volume ID in positions 5 through 10, the sector sequence code is in positions 77 and 78, a W in position 80, and blanks in all remaining positions of the first 80.

Sector 8 contains the following data set labels:

- HDR1 in positions 1-4
- DATA in positions 6-9
- 80 or 128 in positions 25-27 depending on the input specification
- 01001 in positions 29-33
- 73026 in positions 35-39
- 01001 in positions 75-79
- blanks in all other positions

Sectors 9 through 26 contain deleted records with the following content:

- DDR1 in positions 1-4
- DATA in positions 6-9
- Sector number in positions 10-11
- 80 or 128 in positions 25-27
- 74001 in positions 29-33
- 73026 in positions 35-39
- 74001 in positions 75-79
- Blanks in all other positions

As a final step, disk initialization checks the disk to see that it is written correctly.

INITIALIZATION PROCEDURE

To initialize the disk, do the following:

1. Insert a diskette in drive 1. If the disk is bad or uninitialized, you may get several disk errors before X R mode is displayed.
2. Press FUNCT SEL lower, then DELETE REC.
3. Key the following data (each of these fields is optional and can be left blank)

- Volume ID in positions 1-6
- Sector sequence code in positions 7-8 (normally left blank). Valid entries, in addition to the positions being left blank, are shown in Figure 25. Most commonly used are 01 (same as being left blank) and 02. Entering 01 causes the sector arrangement to be 1, 2, 3, 4, 25, 26. Entering 02 causes the sector arrangement to be 1, 3, 5, 25, 2, 4, 24, 26.

- First bad track in positions 9-10
- Second bad track in positions 11-12
- Blank in positions 13-14
- Blank for record length of 80 or L for record length of 128 in position 15

4. Press FUNCT SEL lower, hold down NUM SHIFT and press the I key.

Note: If the numeric shift key is not held down, only the disk checking function occurs. See *Disk Checking* in this chapter.

Blank	01	02	03	04	05	06	07	08	09	10	11	12	13
1	1	1	1	1	1	1	1	1	1	1	1	1	1
2	2	3	4	5	6	7	8	9	10	11	12	13	14
3	3	5	7	9	11	13	15	17	19	21	23	25	2
4	4	7	10	13	16	19	22	25	2	2	2	2	15
5	5	9	13	17	21	25	2	2	11	12	13	14	3
6	6	11	16	21	26	2	9	10	20	22	24	26	16
7	7	13	19	25	2	8	16	18	3	3	3	3	4
8	8	15	22	2	7	14	23	26	12	13	14	15	17
9	9	17	25	6	12	20	3	3	21	23	25	4	5
10	10	19	2	10	17	26	10	11	4	4	4	16	18
11	11	21	5	14	22	3	17	19	13	14	15	5	6
12	12	23	8	18	3	9	24	4	22	24	26	17	19
13	13	25	11	22	8	15	4	12	5	5	5	6	7
14	14	2	14	26	13	21	11	20	14	15	16	18	20
15	15	4	17	3	18	4	18	5	23	25	6	7	8
16	16	6	20	7	23	10	25	13	6	6	17	19	21
17	17	8	23	11	4	16	5	21	15	16	7	8	9
18	18	10	26	15	9	22	12	6	24	26	18	20	22
19	19	12	3	19	14	5	19	14	7	7	8	9	10
20	20	14	6	23	19	11	26	22	16	17	19	21	23
21	21	16	9	4	24	17	6	7	25	8	9	10	11
22	22	18	12	8	5	23	13	15	8	18	20	22	24
23	23	20	15	12	10	6	20	23	17	9	10	11	12
24	24	22	18	16	15	12	7	8	26	19	21	23	25
25	25	24	21	20	20	18	14	16	9	10	11	12	13
26	26	26	24	24	25	24	21	24	18	20	22	24	26

Figure 25. Disk Record Sequences

Any or all of the data in step 3 may be left blank. If the volume ID is left blank, the volume ID will be written as a blank field. If the sector sequence is left blank, the sequence of sectors will be in numeric order (1, 2, 3, ...,25, 26). If no bad tracks are listed, the initialization operations will scan the disk to find any defective tracks marked with the bad track code. When one or two bad tracks are specified, initialization operations do not check for the bad track code and will try to initialize all other tracks.

When the initialization process is complete, the disk is positioned at track 00 and the label in sector 08 is displayed unless errors were encountered. In case of errors, the following is displayed:

- Bad tracks that have been marked with the bad track code are displayed in the first data line. Positions 9 and 10 show the first bad track; 11 and 12 show the second bad track.
- Tracks that showed errors when checked are shown in data line 2 beginning in cursor position 41. Each track shown is written with three characters followed by a space. The first two characters indicate the track number and the third character indicates the type of error encountered:

I = Missing ID field
C = CRC error (diskette data error)
S = Deleted record

Only 10 tracks with errors can be displayed; the first error encountered in a track is displayed.

If errors are displayed after initialization, the initialization was not successful. The disk should be removed to clear errors and initialization tried again until a successful operation occurs. If particular tracks show persistent errors in successive retries, those tracks should be considered defective. Initialization can be retried by specifying those tracks in the keyed data of step 3. Since the maximum number of bad tracks that can be specified is two, disks with persistent errors in more than two tracks cannot be used.

DISK CHECKING

The initialization feature provides a means of checking a disk for tracks marked with the bad track code and for tracks exhibiting errors. The procedure for checking is as follows:

1. Insert a diskette into drive 1
2. Press FUNCT SEL lower and DELETE REC
3. Press FUNCT SEL lower
4. Press the I key

At the end of the scan, a report is posted on the display in the same format as used for reporting errors after initializing. If errors are reported, the disk should be checked repeatedly and only tracks that show persistent errors in repeated operations should be considered bad.

Figure 26 shows the errors and recovery action for disk initialization errors.

Code	Type	Causes	What You Do
	Input specification	Track 00 or 78 to 99 were specified as a bad track. Sequence is greater than 13. A character other than 0-9 or blank was entered or an odd number of characters entered in positions 7-12.	Reset** and correct error.
=	Bad track specification	Bad tracks are not entered in ascending sequence.	Reset** and re-enter in ascending sequence.
*	Bad tracks	More than two bad tracks are on the disk.	Reset** and retry disk initialization. If error persists, discard disk.
(Write error	Disk error occurred while initializing the disk.	Reset** and retry initialization.
&	Sector not deleted	One of the normally deleted sectors (9-26) on the index track was not deleted. Sequence number keyed was 00.	Reset** and retry initialization.
<p>**Initialization errors are not reset by the reset key. The disk is removed and reinserted; then the initialization setup must be done over.</p>			

Figure 26. Disk Initialization Errors

The self-check feature provides a method for checking the entry in numeric fields that contain a precomputed self-check digit. The self-check digit is the last digit in the field, and has been precomputed by using either of two algorithms, modulus 10 or modulus 11.

In the modulus 11 operation, basic numbers that require a check digit of 10 cannot be used as self-checking numbers. The accounting system must be adjusted to eliminate such numbers from codes that are to be self-checked. If an operator is entering or verifying check digits and uses a basic number requiring a check digit of 10, the machine indicates an error condition.

Self-check fields are specified in the program by the use of the following characters:

- H — Modulus 10
- C — Modulus 11
- F — Modulus 10 skip
- G — Modulus 11 skip
- L — Modulus 10 duplicate
- M — Modulus 11 duplicate

Fields defined by the characters F and G act as skip fields when the AUTO DUP/SKIP switch is on, and as manual self-check fields when the AUTO DUP/SKIP switch is off. Fields defined by the characters L and M act as dup fields when the AUTO DUP/SKIP switch is on and as manual self-check fields when it is off.

When duplicate or skip and self-check are combined in a field, the self-check is performed after the auto function. If a self-check error is found, turn off the AUTO DUP/SKIP switch to backspace, and correct the self-check number.

Blank fields check correctly in the enter mode, but cause a C error in verify or field correct mode. This allows a self-check field to be skipped in enter mode and entered later in verify mode.

Numerals 0 through 9 and all other EBCDIC characters with the values 0 through 9 in the low-order hex digit are totaled by the low-order hex digit value. All other characters are totaled as the value zero.

If self-check errors occur, three methods of error recovery are:

1. Press RESET to unlock the keyboard and remove the error condition. This permits entry of a new character or backspacing to correct a preceding character.
2. Press the dash key with either shift key to (a) remove error condition, (b) overscore the units position with the high order hex D, and (c) exit from the field.
3. Press NUM SHIFT and the & key to (a) remove error condition, (b) overscore the units position with the high order hex C, and (c) exit from self-check field.

COMPUTING THE SELF-CHECK DIGIT

Modulus 10

Modulus 10 can be computed for any number from 2 to 127 digits long. To compute modulus 10, do the following:

1. Multiply the units position and every alternate position of the basic number, excluding the self-check digit, by 2.
2. Add the digits in the products to the digits in the basic number that were not multiplied.
3. Subtract the sum from the next higher number ending in zero.

The difference is the self-check digit.

For example:

Basic number	6	1	2	4	8
Units position and every alternate position of basic number	6		2		8
Multiply	12		4		16
Digits not multiplied		1		4	
Add	$1+2+1+4+4+1+6=19$				
Next higher number ending in 0	20				
Subtract	-19				
Self-check digit	1				

Modulus 11

To compute modulus 11, do the following:

1. Assign a weighting factor to each digit position of the basic number. These weighting factors are 2-7, 2-7, etc. starting with the units position of the number, excluding the self-check digit, and progressing toward the high-order digit.
2. Multiply each digit by its weighting factor.
3. Add the products.
4. Divide this sum by 11.
5. Subtract the remainder from 11.

The difference is the self-check digit.

For example:

Basic number	1	2	3	4	5
Weighting factors	6	5	4	3	2
Multiply	6	10	12	12	10
Add	$6+10+12+12+10=50$				
Divide	$50 \div 11 = 4$ plus a remainder of 6				
Subtract	$11-6=5$				
Self-check digit	5				

The 3741 Models 2 and 4 are supported as standard BSC terminals for point-to-point communications on switched or nonswitched facilities, or multipoint communications on nonswitched facilities. Operation is half-duplex, synchronous, serial-by-bit, serial-by-character. The BSC allows data transmission using EBCDIC directly as the communications line code.

The 3741 Models 2 and 4 operate in half-duplex mode via appropriate modems over the following networks:

- Switched common-carrier network at 600, 1200, 2000, or 2400 bps.
- Nonswitched common-carrier, voice-grade, private-line data channels (or equivalent privately owned facilities) at 600, 1200 or 2400 bps.

Note: The grade of channel and type of channel conditioning must be as specified by the modem supplier.

The private-line channels may be half-duplex or duplex, point-to-point. Although the 3741 Models 2 and 4 operate in half-duplex mode, duplex private-line facilities are recommended to minimize line-turnaround times. Refer to the publications, *General Information Binary Synchronous Communications*, GA27-3004, and *IBM Teleprocessing Systems Summary*, GA24-3090, for additional information pertaining to communications facilities.

The exact network configuration of the 3741 Model 2 or 4 depends upon the application. Figure 27 shows some typical configurations.

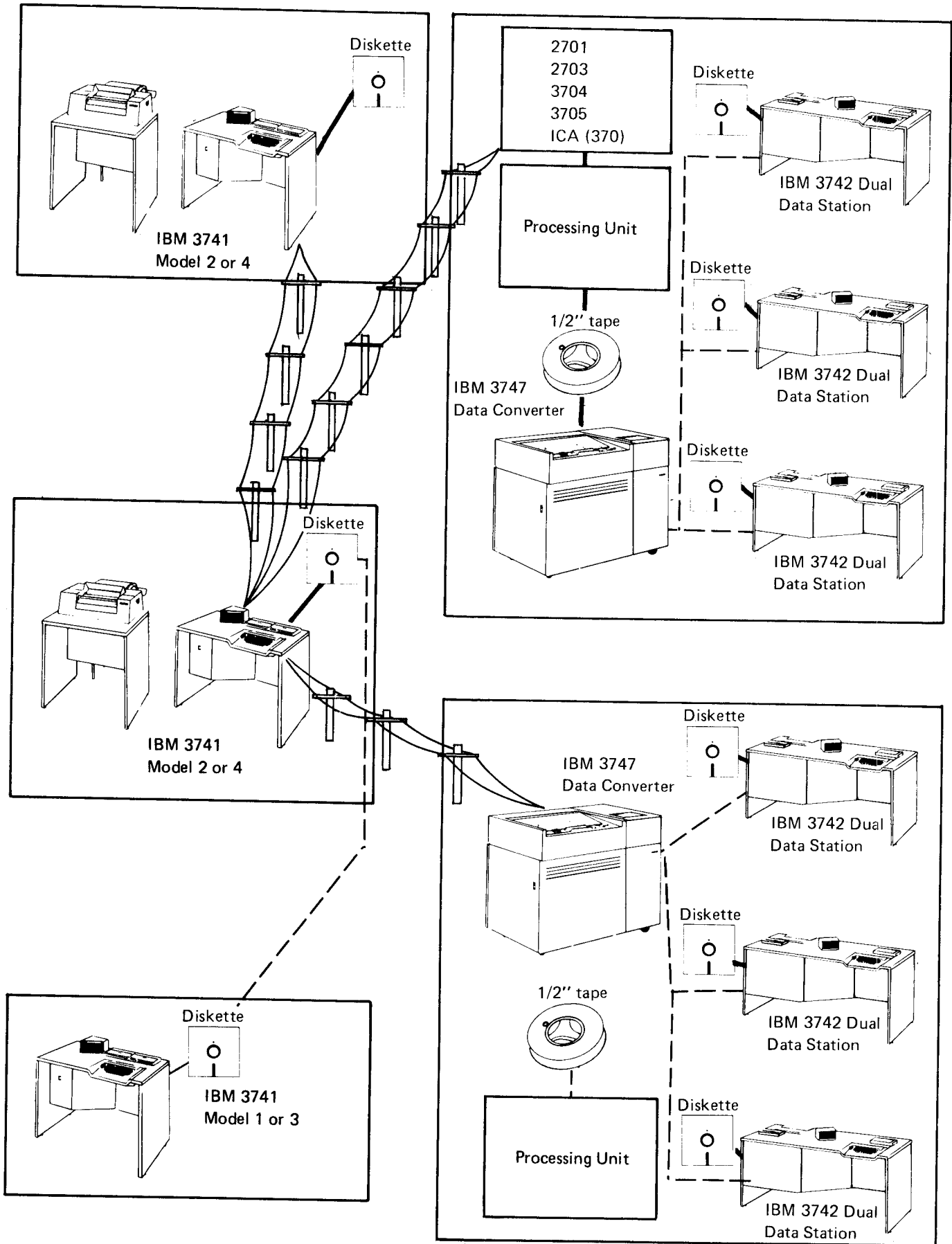

Figure 27 (Part 1 of 2). 3741 Model 2 or 4 Communications Configurations

Nonswitched Common Carrier, Voice Grade

A nonswitched, point-to-point or multipoint network consists of dedicated, private, or leased communication lines. Nonswitched point-to-point networks connect the 3741 Model 2 or 4 with remote terminals or processing units. Nonswitched multipoint networks connect the 3741 Model 2 or 4 with a processing unit. On a nonswitched network, the terminals are physically connected: that is, the circuits making up the communication lines are continuously established for predetermined time periods during which data may be transmitted over the lines. Since the terminals are continuously connected, no dialing is required.

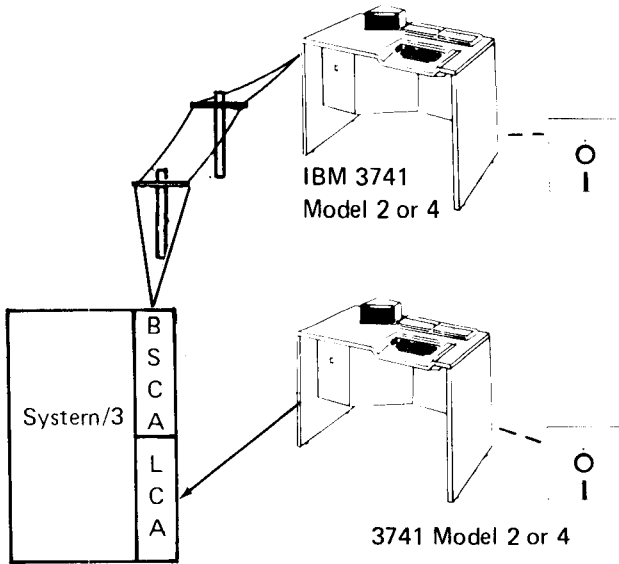

Figure 27 (Part 2 of 2). 3741 Model 2 or 4 Communications Configurations

Networks

The 3741 can use a switched or nonswitched network for point-to-point communications or nonswitched network for multipoint communications. See Figures 28 and 29.

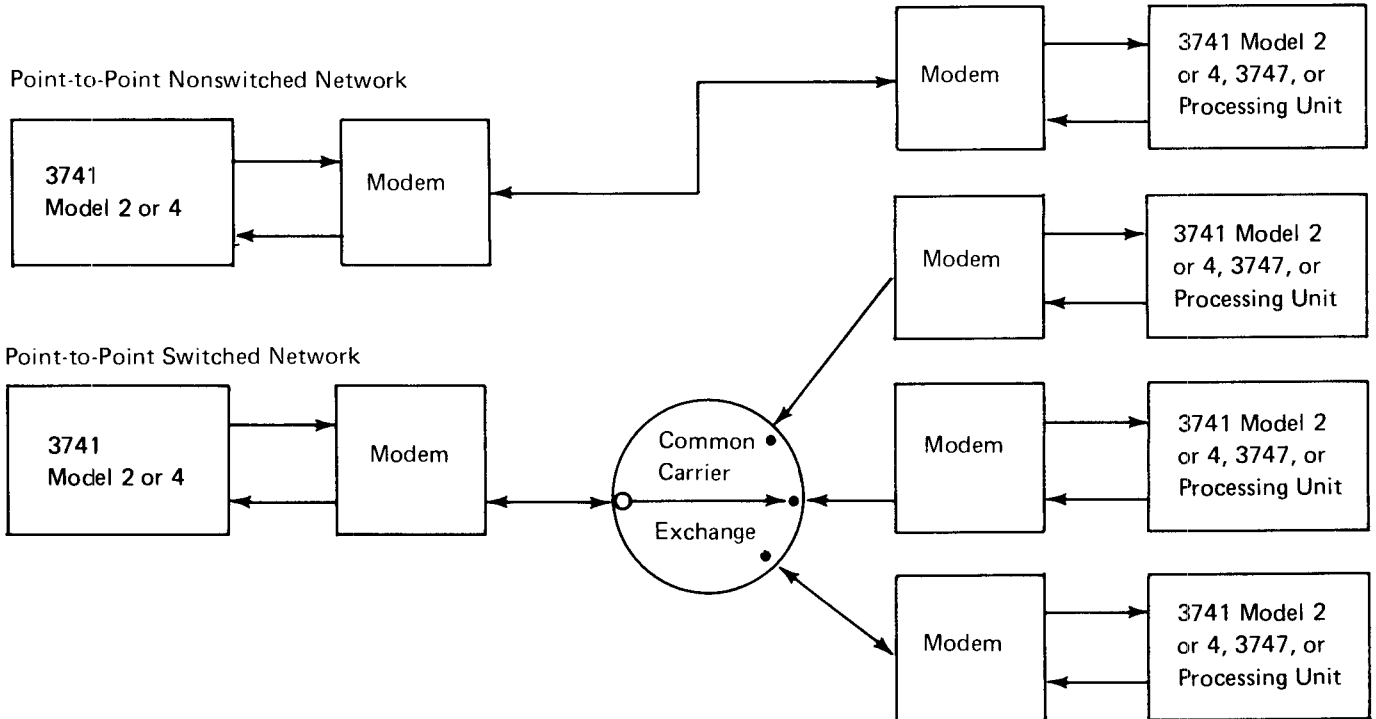

Figure 28. Point-to-Point Telecommunications Networks

Switched Common Carrier

A switched network allows the 3741 Model 2 or 4 to communicate with many other terminals or processing units without requiring dedicated communication lines. The terminals are connected by access lines to the common carrier exchanges servicing their respective locations. A complete and continuous data path is established between terminals only for the period of time in which data transmission takes place. The connection is established by dialing the telephone number of the remote terminal or processing unit.

Normally, the station placing the call should bid the line. On switched lines, and if the operator will be dialing the call, the M key must be pressed. This indicates who is calling, and that the controller will transmit a line bid first regardless of the mode. Not pressing the M key tells the controller to wait for a line bid. (The requirement for pressing the M key is shown in Figure 44 [Part 3 of 5].) Pressing the M key must be omitted if the 3741 will be answering a call or if on nonswitched lines.

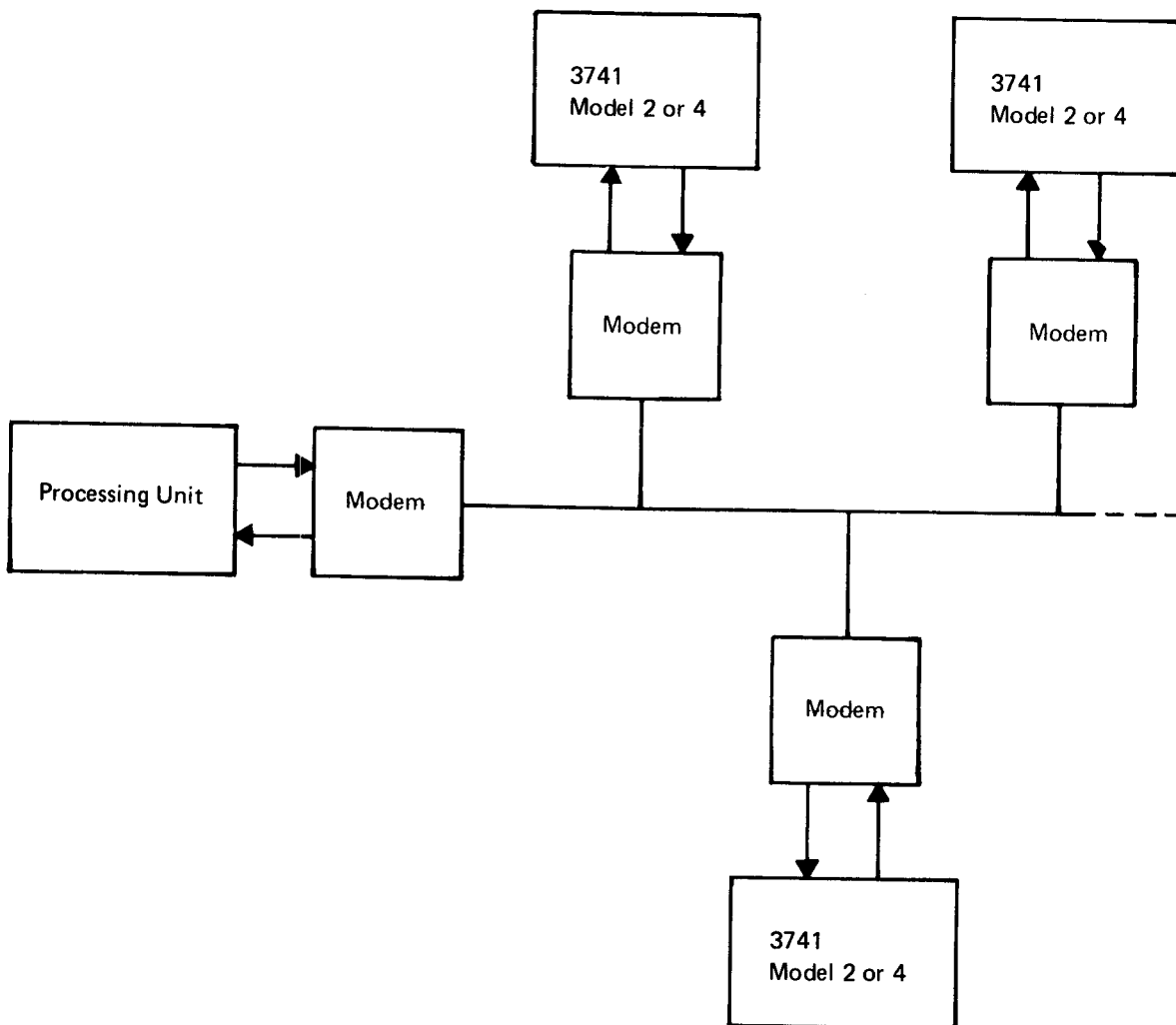

Figure 29. Leased Multipoint Telecommunications Network

Modem (Data Set)

An external modem or integrated 1200 bps modem connects the terminal to the telephone lines. The bit rates available are 1200, 2000, and 2400 bits per second (bps). A selectable 600 bps transmission rate is available except in the United States, Canada and Japan. The 3741 communications adapter is compatible with the IBM 3872 modem and the IBM integrated 1200 bps modem.

A synchronous clock feature is available for use with modems that do not have their own internal clocking (see *Features*).

The modem required by the 3741 Model 2 or 4 may be supplied by IBM, the common carrier, or the customer and must be identical on both ends of the network. The modem interface must conform to the electrical characteristics as specified by EIA Standard RS-232C and be operationally compatible with the 3741 Model 2 or 4 modem interface. Attachment is made via a modem interface cable that is terminated by a 25-pin modem connector plug. The following circuits described in RS-232C are used by the 3741 Models 2 and 4:

Connector Pin	RS232C Designation	Circuit Description
1	AA	Protective ground
2	BA	Transmitted data
3	BB	Received data
4	CA	Request to send
5	CB	Clear to send
6	CC	Data set ready
7	AB	Signal ground (common return)
15*	DB	Transmit signal element timing
17*	DD	Receiver signal element timing
18	None	IBM 3872 wrap test
20	CD	Data terminal ready
22	CE	Ring indicator
23	CH	Data Signal rate selector

*Used only when operating with synchronous modems.

Additional modem-interface information is available from your IBM representative.

FEATURES

The following features are available for the 3741 Models 2 and 4.

Synchronous Clock

The synchronous clock feature provides business machine clocking of the data onto and off of the transmission line. The bit rate for this feature is 1200 bps (600/1200 except in the United States, Canada and Japan). This feature should be used only when the attached modem does not provide its own clocking. The terminal that the 3741 is communicating with must also be equipped with business machine clocking.

Terminal Identification

The terminal identification feature transmits a 4-character terminal identification sequence and compares a received identification sequence with a keyed-in sequence. This feature cannot be installed if the multipoint communication network is utilized.

Transmitting the Terminal Identification Sequence

The BSC terminal transmits a 4-character identification sequence when initiating a line bid or when responding to a line bid.

If the 3741 is the calling station, the first transmission on a switched network after a connection has been established is the following sequence:

```

PPPSS      EP
AAAYYvabcNA
DDDNN      QD
    
```

The lowercase v (hex A5) is the terminal type character (3741 Models 2 and 4).

A unique 3-character sequence will be a factory-installed sequence assigned by IBM from a master list. The master list consists of characters from all positions of the EBCDIC code set with the exception of SOH, STX, ETX, EQT, ENQ, ACK, DLE, NAK, SYN, ETB, IUS, NUL, DEL, and EO.

If the 3741 is the called station, the first transmission after receiving a line bid is the following sequence:

```

PPPSS      A P
AAAYYvabcC0A
DDDNN      K D
    
```

If the terminal is not prepared to receive a line bid, the following sequence is transmitted:

```
PPPSS      NP
AAAYYvabCAA
DDDNN      KD
```

Remote Terminal Identification Compare

This function allows the operator of a 3741 Model 2 or 4 to check the identity of a remote terminal before proceeding with data communications between the 3741 Model 2 or 4 and the remote terminal. An operator keyed sequence of characters is compared to a terminal identification sequence received on the communications line. The transmission or reception of data begins after the received terminal identification sequence matches character for character and has the identical length as the keyed sequence.

The operator keys the remote terminal identification sequence while the station is in the update or read index mode. A sequence of up to 15 characters must be positioned with the first character in position 1 of the current record buffer and the cursor in the next position following the last character of the sequence. If the cursor is left in the first position, indicating that no characters have been keyed, the BSC terminal accepts any remote terminal identification sequence of up to 15 characters, and the transmission or reception of data occurs as though the terminal identification feature were not installed. If the cursor is left in a position indicating that more than 15 characters have been keyed, an error is displayed after FUNCT SEL and COMM are pressed.

Note: If the remote terminal identification sequence contains characters not represented on the 3741 keyboard (for example, lower case alpha characters), the operator must enter the hexadecimal equivalent using the HEX key.

After the identification characters have been keyed, the operator places the 3741 in one of the communication modes by pressing FUNCT SEL, COMM, and the desired mode key. The keyed remote terminal identification sequence is transferred from the current record buffer to program buffer 9 and erased from the display. (Program buffer 9 is not used if you have the expanded communications feature.) This sequence is stored as long as the terminal is in a communications mode.

When the terminal is the calling station, the terminal compares the identification sequence of the response to its line bit with the operator keyed sequence. If the sequences match and the response is positive, the terminal prepares to transmit or receive data blocks. If the sequences match and the response is negative, the terminal disconnects with an X error. If the sequences do not match, the terminal transmits its line bid up to 14 times before disconnecting with a C error.

When the terminal is the called station, the remote terminal identification sequence of the received line bid is compared to the operator keyed sequence. If the sequences match, the terminal gives a positive response and prepares to transmit or receive data blocks. If the sequences do not match, the terminal does not respond, but does continue to wait for a valid sequence.

Note: Program buffer 9 is used whenever the Terminal Identification Feature is installed. Therefore, any program previously stored in program buffer 9 is displaced during communications functions. Program buffer 9 is not used if you have the expanded communications feature.

Operator Identification Card Reader

This feature is used to read an operator identification card and transmit the information to a CPU that is programmed to accept only valid sequences. This feature can be bypassed if the 3741 terminal is transmitting to another terminal. This is done by pressing record advance.

When the 3741 terminal is in one of the transmit modes, a letter B is displayed to the right of the mode indicator. The operator must then insert the identification card into the card reader. After the card has been read, the B is erased and the terminal is ready to transmit; if an error is detected, no action is recorded and the card may be read again.

For information on the format of the magnetic stripe, see the *IBM 3740 BTAM/TCAM Programmer's Guide*, GC21-5071.

Note: Program buffer 9 is used whenever the Operator Identification Card Reader Feature is installed. Therefore, any program previously stored in program buffer 9 is displaced during communications functions. (Program buffer 9 is not used if you have the expanded communications feature or the expanded communications/multi-point feature.)

Keylock

This feature controls the use of the communication mode. In the locked position communication mode cannot be used and in the unlocked position it can be used. The 3741 terminal can also be locked in a communications mode permitting communication with a remote terminal. However, once the 3741 is removed from COMM, the key must be used to permit re-entry. Also, if the first or second disk is removed, communications mode is discontinued.

A transmit selected records program is defined by an equal sign (=) in the first position of a program buffer. The remainder of the program consists of a search argument (the data in the record must match the search argument in order to be selected for transmission) and equal signs (the equal signs represent "don't care" positions). There can be no search argument in position 1 of the program buffer. The transmit selected records program can be loaded into program buffers 8, 9, or A. See *Program Control* for considerations concerning the loading of these program buffers. The following is an example of transmit selected records:

```
Data Record 0000000100000000ROCHESTER00MN00000000124
Buffer Content =====ROCHESTER00MN=====
Trans. Data 0000000100000000ROCHESTER00MN00000000124
```

OPERATION	MODE	BUFFERS USED
Transmit	T, P, B, or D	F
	J or K	F, 1, 2, 3, 4, 5, 6, and 7
Receive	R, B, D, or K	128 data characters
		256 data characters
		384 data characters
		512 data characters
		F, 2 and 6
		F, 1, 2, 5, 6
		F, 1, 2, 4, 5, 6
		F, 1, 2, 3, 4, 5, 6, 7
F = field totals accumulator buffer Numerics = program buffers		

Notes:

1. Program buffers not listed are not affected by this specific operation.
2. When the expanded communications feature and the terminal ID or operator ID card read feature are installed, the previous buffer is used instead of program buffer 9 for terminal ID or operator ID card reader features.
3. The last data placed into these buffers remains in the buffers after transmission is complete. The operator must clear these buffers and reload them with programs as required.

Figure 30. Buffers Used by the Expanded Communications Buffer Feature

Unattended ACL Program Execution (Model 4 Only)

The expanded communications feature enables you to have unattended ACL program execution after the completion of communications. The operator can set up the unattended ACL program execution function by keying FUNCT SEL upper and COMM, the character E, and then the appropriate mode key.

Sector 3 of the index track of disk 1 must contain the information required to translate or execute an ACL program. Figure 31 lists the information required for translation and Figure 32 lists the information required for execution.

Position	Required Information
2-9	Source data set name.
10	1 or 2 depending on which disk drive the source data set is mounted. Default is 1.
12-19	Object data set name.
20	1 or 2 depending on the disk drive the object data set is mounted on. Default is 1.
21	The character A.

Figure 31. Information Required for Translation

Position	Required Information
2-9	Object data set name.
10	1 or 2 depending on which disk drive the object data set is mounted. Default is 1.
12-15	ACL program name.
21	The character E.

Figure 32. Information Required for Execution

After communications is complete, the data in sector 3 is shifted one position to the left and displayed. Then the ACL program translation or execution is initiated.

Program Control

For the expanded communications feature, it is assumed that program buffers 8, 9, and A are used to store transmit selected fields programs, transmit selected records programs, and receive data and insert constants and blanks. A maximum of three data sets can be transmitted and/or received under program control. Each communications program that is loaded into a program buffer applies only to one data set. For example, if program buffers 8, 9, and A are loaded as follows:

```

8      """"""T0B . . . . . (transmit selected fields)
9      =000EF . . . . . (transmit selected records)
A      +00102 . . . . . (printer program)
    
```

The first transmitted data set would be under control of the transmit selected fields program (program buffer 8), the second transmitted data set would be under control of the transmit selected records program (program buffer 9), and all subsequent transmitted data sets would be transmitted without program control. The first data received would be printed unattended under control of program buffer A if the operator selected print unattended mode during communication selection.

Program buffers 8, 9, and A remain active after the current communication is complete. That is, if communications mode is selected again, these buffers are used again. Therefore, if after communications is complete you will not be using these buffers, they should be cleared of any communications programs (transmit selected fields, transmit selected records, receive data and insert constants, or print unattended).

Figure 33 shows the possible relationships between the program buffers used for the functions of expanded communications and the data sets transmitted and/or received. Note that a transmit selected fields or records program must not follow a receive data and insert constants program in order for buffers to be used.

Expanded Communications/Multipoint Data Link Control Feature

This feature provides all of the functions described under *Expanded Communications Feature* and also provides the following additional functions for the 3741 Models 2 and 4.

- Nonswitched multipoint communications capability.
- Inquiry capability under multipoint data link control.

Multipoint communications allows the 3741 and other terminal devices to communicate with a processing unit on a dedicated network. The 3741 on a multipoint network only serves as a tributary station. The 3741 can monitor the line at all times and respond to its own polling and selecting sequences as appropriate. When in transmit mode, the 3741 responds to a poll by transmitting data. When in receive mode, the 3741 responds to selection with a positive acknowledgement. If the 3741 is not ready to receive, it responds with a negative acknowledgement to selection. When the 3741 is not in communications mode, the operator is also notified (a tone is heard) that the processing unit has data to send and that the 3741 should be placed in receive mode. If the 3741 is not ready to transmit when polled, it responds with EOT. If the 3741 is ready to transmit and is selected, it responds with RVI.

This function of the Expanded Communications Multipoint Data Link Control Feature allows the operator to key a single record inquiry message, transmit the inquiry to a remote processing unit and receive a response to the inquiry. Both the inquiry message and the response are recorded in a data set on disk and can be displayed by the operator. See *Inquiry Mode (I)* and *Operating Procedures* for more information.

		PROGRAM TYPE IN PROGRAM BUFFER																										
		Program Buffer 8	T	-	-	T	-	T	T	R	-	-	R	-	R	R	T	T	-	T	T	R	R	R	R	-	T	R
		Program Buffer 9	-	T	-	T	T	-	T	-	R	-	R	R	-	R	R	-	T	T	R	T	-	R	T	R	R	T
		Program Buffer A	-	-	T	-	T	T	T	-	-	R	-	R	R	R	-	R	R	R	R	-	T	T	T	T	T	R
Program Buffer Number Controlling	First Transmitted Data Set		8	9	A	8	9	8	8								8	8	9	8	8							8
	Second Transmitted Data Set					9	A	A	9										9									
	Third Transmitted Data Set								A																			
	First Received Data Set									8	9	A	8	9	8	8	9	A	A	A	9	8	8	8	8	9	9	8
	Second Received Data Set												9	A	A	9				A				9				A
	Third Received Data Set																A											

- T = A transmit selected fields or records program.
- R = A receive data and insert constants program
- = Program buffer does not contain a transmit selected fields, records, or receive data and insert constants program.
- ∅ = Any data sets transmitted or received are not under program control.

Note: The contents of program buffers 8, 9, and A remain active after communications is complete. That is, if communications mode is again selected, these buffers would be used in controlling the transmitting or receiving of data. Therefore, if these program buffers are not required after their initial use for one communications process, their contents should be deleted.

Figure 33. Expanded Communications Program Buffer Usage

Programming Support

Teleprocessing programming support is provided for the 3741 Models 2 and 4 by the following access methods and operating systems:

System/370	System/3 Disk Systems
DOS/VS BTAM	RPG II
DOS/VS VTAM	
DOS/VS CICS	IBM 3704/3705
DOS/POWER/VS	
OS/VS BTAM	Emulation program (EP)
OS/VS TCAM	Network control program (NCP)
OS/VS VTAM	
OS/VS CICS	
OS/VS1/RES	
OS/VS2/JES2	

In addition to this programming support, the 3741 can be used as an RJE (remote job entry) terminal controlled by JES2 or POWER/VS RJE. Also, the 3741 Models 2 and 4 can communicate with either a 3747 with BSCA or another 3741 Model 2 or 4.

The 3741 Models 2 and 4 are transparent to the teleprocessing support that exists in System/360-370 DOS BTAM and System/360-370 OS BTAM and TCAM. The 3741 Models 2 and 4 are transparent through the device classes of BSC1, BSC2, and BSC3 in BTAM and TCAM.

Because of this capability, the following support is also available:

System/370	System/360
DOS BTAM	DOS BTAM
OS BTAM	OS BTAM
OS TCAM (level 5)	OS TCAM (level 5)

Communications with System/360-370 can be:

- IBM System/370 via:
 - IBM 2701 Data Adapter Unit
 - IBM 2703 Transmission Control Unit
 - IBM 3704 and
 - IBM 3705 Communications Adapter in emulator or NCP mode
 - IBM System/370 Models 135, 125 or 115 via an ICA (Integrated Communications Adapter)
- IBM System/360 via:
 - IBM 2701 Data Adapter Unit
 - IBM 2703 Transmission Control Unit
 - IBM 3704 and
 - IBM 3705 Communications Adapter in emulator mode only

In BTAM and TCAM, the terminal designation is BSC1, BSC2, or BSC3 depending on whether a nonswitched or switched facility is being used. In VTAM, the terminal designation is 3740. In System/3 RPG II, the terminal designation is BSCA on the file description specification and is blank in the remote device field of the telecommunications specifications.

COMMUNICATION MODES

The 3741 can transmit all the information on a disk, receive information and store it on a disk, or transmit the information on part of a disk and then receive information on the rest of the disk. The 3741 cannot receive information and then transmit. Transmit and receive operations can consist of single or multiple data sets.

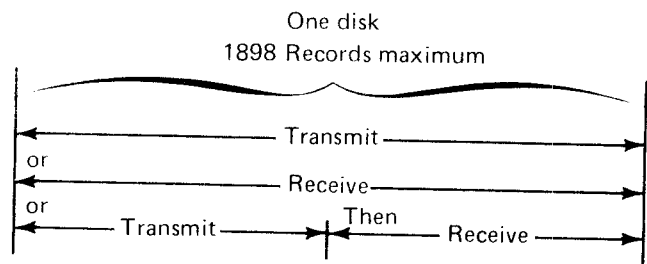

With the second disk feature, the same functions offered with one disk are available across two disks. However, when operating in the combined transmit/receive mode and transmitting from disk 2, the data being transmitted can only be a continuation of the last data set transmitted from disk 1.

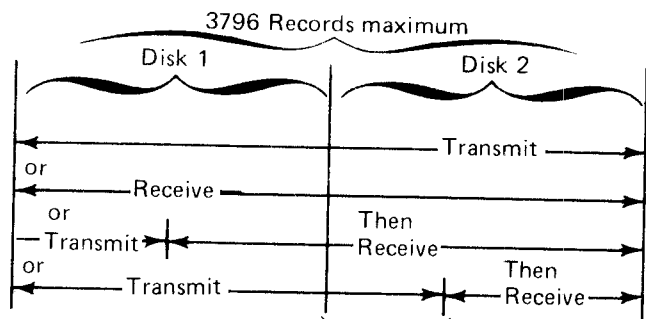

The binary synchronous communications feature checks to determine which data set labels are set up for data set transmission (transmit mode), which data set labels are to be used to identify data sets received (receive mode), or which data set labels are set up for data set transmission and which data set labels are to be used to identify data sets received (transmit/receive mode). Figure 34 summarizes the effect of data set label status on data sets in the various BSCA modes.

The following further describes the individual BSCA modes.

Transmit Mode (T)

Transmit mode is used to transmit data from one disk or two disks (if the second disk feature is installed) to a remote location. Transmission begins with the first data set label or record selected and continues to the end of the data set labels unless the labels are deleted, bypassed, or a label error is detected.

After loading the disks to be transmitted, an operator places the 3741 in transmit mode by pressing FUNCT SEL upper, COMM, and T. A T will then be displayed on the status line of the display to indicate the transmit mode.

When the 3741 is in transmit mode, it can be connected to the telephone line through a modem, and subsequently transmit data from the disk to the remote location.

The procedure in the previous paragraph was for transmitting one or two disks in their entirety. If the operator desires to start transmission from any position on the first disk, the operator can position the disk to any record of any data set with normal key entry operations, and subsequently start the transmission of data from that point.

If transmission occurs with no errors, a TT is displayed on the display's status line to indicate a completed transmission. If a disk error, invalid data set label, or a transparency error occurs, TI will be displayed in the display's status line to indicate an incompleting transmission. If the mode indicator is TT or TI, the 3741 will not automatically answer a telephone call. If the mode indicator remains T (as it would if a line check, remote abort, or message aborted error occurred), the 3741 will answer a telephone call and will retransmit the data beginning at the same place as the original call. However, on early shipments of the 3741 Model 2, if the communications mode was selected with a data set record displayed, the operator must reposition the disk to the original starting position. Your 3741 can be field upgraded so that the operator does not have to reposition the disk to the original starting position. Contact your IBM representative for more information. If your 3741 has not been field upgraded and you are performing unattended operations, it is recommended that the communications mode be selected while the label is displayed.

If you intend to use any transmit mode, do not write a % character as data in position 1 of disk address 01001 since this unique condition is reserved for initiating a BSCA diagnostic procedure.

Expanded Communications Transmit Mode (J)

The expanded communications transmit mode (J) is similar to the transmit mode (T) of operation except that multiple records are transmitted in each transmission block. The last character of each record in the buffer is followed by an IRS (inter-record separator) character which defines the end of that record. The IRS character occupies a byte position in the 512-byte buffer and is transmitted to the receiving system. Records are read from disk into the 512-byte buffer until a complete record and IRS character cannot be contained in the buffer. Thus, records are not spanned between transmission blocks. Refer to the host system's reference manual for more information.

The IRS (X'1E') and IFS (X'1C') characters cannot be sent as data in the J mode of operation. If these or any other data link control characters are read from disk, a transparency error results. The IRS or IFS character can be transmitted in transmit (T), transmit/receive (B), transmit-transparent (P), or transmit-transparent/receive (D) mode.

The operator identification card data is transmitted as a separate block without a following IRS character. The format of this block is described in the *IBM 3740 BTAM/TCAM Programmer's Guide*, GC21-5071.

Transmit-Transparent Mode (P)

The transmit-transparent mode is used to transmit over the communication lines all 256 EBCDIC bit combinations as data. After loading the disks, an operator can place the 3741 in a transmit-transparent mode by pressing FUNCT SEL upper, COMM, and P. A P will then be displayed on the status line of the display to indicate the transmit-transparent mode.

This mode of operation is identical to the transmit mode with the exception that data is transmitted in transparent mode. PI indicates an incompleting transparent transmission; PT indicates a completed transparent transmission.

Disk Data Set Label	Transmit Mode	Receive Mode	Transmit/Receive Mode			
			On Disk 1		On Disk 2	
			Transmitting	Receiving	Transmitting	Receiving
Normal Data Set Label: <ul style="list-style-type: none"> • Has HDR1 in positions 1 through 4 • Has valid extents and record length • Is accessible • Is not deleted • Is not a bypassed data set (B in position 41) 	Data set will be transmitted.	Label will be used in receiving data	Data set will be transmitted	Not used because label identifies data set that was transmitted	Data set will be transmitted if: <ol style="list-style-type: none"> 1. it is the first data set (00008) 2. it is a continuation of the last data set transmitted on disk 1. 	Label will be used in receiving data
Bypassed Data Set Label: <ul style="list-style-type: none"> • Has HDR1 in positions 1 through 4 • Is accessible • Has valid extents and record length • Is not deleted • Has a B (bypass) in position 41 	Data set will not be transmitted	Label will be used in receiving data	Data set will not be transmitted	Labels beyond the last transmitted data set will be used in receiving data	Data set will not be transmitted	Label will be used in receiving data
Deleted Data Set Label or Invalid Data Set Label: <ul style="list-style-type: none"> • Does not have HDR1 in positions 1 through 4 • Has invalid extents or record length* • Is not accessible • Is deleted 	Data set will not be transmitted	Label will not be used in receiving data	Data set will not be transmitted	Label will not be used in receiving data	Data set will not be transmitted	Label will not be used in receiving data

*The extents and record lengths are not checked after the first received data set.

Note: The write protect byte of a data set label is checked only for the first data set to be received on either disk. Subsequent data set labels are not checked. Therefore, caution should be used to ensure write protected data is not written over during receive operations. On early shipments of the 3741 with binary synchronous communications, the write protect byte status of the first used label was not used. Your 3741 can be field upgraded so that the write protect byte can be used. Contact your IBM representative for more information.

Figure 34. Effect of Labels on BSCA Modes

Receive Mode (R)/Expanded Communications Receive

The receive mode is used to receive data from a remote location and store that data on one disk or two disks (if the second disk feature is installed). After loading the disks, an operator can place the 3741 in receive mode by pressing FUNCT SEL upper, COMM, and R. An R will then be displayed on the status line of the CRT display to indicate the receive mode.

The 3741 can then be connected to the telephone line through a modem and subsequently receive data from the remote location and store it on the disk(s).

Data records received with an STX are received in the non-transparent mode; records received with a DLE STX are received in the transparent mode.

Note: When data sets are received, data is written compactly on the diskette. The 3741 modifies the extents in the labels associated with the received data. This modification occurs independent of the extents previously identified in any of the labels on the diskette. The modification of the extents also occurs independent of the write protect status of the second and any succeeding receive data set labels. This means that if a diskette is used for receiving data that has write protected data sets, it is possible that the write protected data may be written over with the received data. Therefore, you should exercise caution when using diskettes with write protected data sets that are used for receiving data.

Because of the possibility of write protected data sets being written over in receive modes, it is suggested that one of the following techniques be used to minimize the possibility of write protected data being written over.

1. If the same number of data sets are received, during each communication, set up the exact number of data set labels as required for the job and then always receive data into the same data sets.
2. If a variable number of data sets are received, set each data set to null (empty) by making EOD equal to BOE in each data set label. Then after each communication you can tell which data sets have received new data because the extents in the data set label are modified if data was written into the data set.
3. Another technique that can be used when a variable number of data sets are received is to keep the number of data sets fixed by having the processing unit transmit a null data set for each daily inactive file. In this manner, the number of data sets received each day remains constant and you can set up the exact number of data set labels required and then always receive data into the same data sets.

The labels for the data set to be received must be valid HDR1 (or bypassed) labels and must not be deleted. The BSCA feature will modify the following fields of the label:

Record Length: The record length is determined from the length of the first record received in the data set if the disk was positioned on the data set label when the operator selected communications mode. If the disk was positioned on a record within the data set, the record length is determined by the record length specified in the corresponding label.

Beginning of Extent: The beginning of extent (BOE) is not changed on the label of the first data set received and is made equal to the end of data (EOD) of the previous data set for all succeeding data sets received. (See Figure 37 for summary of extents generated during receive mode operation.)

	BOE	EOD	EOE
First received data set on first disk	BOE of the label	BOE + number of records received	EOD - 1 (if null data set, EOD)
Succeeding data sets on first or second disk	Previous EOD	BOE + number of records received	EOD - 1 (if null data set, EOD)
First received data set on second disk	01001	BOE + number of records received	EOD - 1 (if null data set, EOD)

Figure 37. Generated Extents while in Receive Mode

End of Extent: The end of extent (EOE) address is made equal to the record address of the last recorded record.

End of Data: The end of data (EOD) is made equal to the end of extent plus 1, except when a null data set is received. In this case, the end of data and end of extent are made equal to the beginning of extent address.

Multivolume Indicator: The multivolume indicator of the first disk is changed to a C (continued data set) when the overflow of the first disk is written on the second disk. The multivolume indicator of the second disk is changed to an L to indicate the last disk of a continued data set. All other label information is left unchanged.

If the operator desires to start recording received data from any position on the first disk, the operator can position the disk to any record of any data set with normal key entry operations, and subsequently start receiving and recording data from that disk position.

If one or two disks of data are received with no errors, an RC is displayed on the display's status line to indicate a completed reception of data.

If a disk error occurs or if the disk(s) is full, then RJ will be displayed on the display's status line. The 3741 will not automatically answer a telephone call if the mode indicator indicates RC or RJ. For RC, the operator can check status and mount new diskettes. For RJ, the operator must correct or bypass the error condition in order to continue receiving data.

If the mode indicator remains R (as it would in a line check, remote abort, or a length check occurred), the 3741 will answer a telephone call and will receive the data beginning at the same place as the original call. However, on early shipments of the 3741 Model 2, if communications mode was selected with a data set record displayed, the operator must reposition the disk to the original starting position. Your 3741 can be field upgraded so that the operator does not have to reposition the disk to the original starting position. Contact your IBM representative for more information. If your 3741 has not been field upgraded and you are performing unattended operations, it is recommended that the communications mode be selected while the label is displayed.

Notes:

1. SOH, STX, or DLE STX in non-transparent or DLE STX (when not immediately preceded by a DLE) in transparent text will be recognized as control characters and will be deleted from the text. Other BSC products may not prohibit the transmission of these control characters in text even though such characters are not supposed to be in text.
2. The following characters cannot be received as data in the non-transparent mode: SOH, STX, ETX, ETB, EOT, ENQ, DLE, NAK, ITB, and IRS (only for expanded communications).

With the expanded communications feature in receive mode, the 3741 has the capability of receiving non-transparent transmission blocks containing up to 512 bytes of data and IRS characters. Each record must be separated by IRS characters if more than one record per transmission block is to be received. Records can be spanned between two transmission blocks. Transmission block lengths must be greater than the length of each record, except for the last transmission block of the data set. One record per transmission block in either transparent or non-transparent text can also be received with the expanded communications feature. When the transmission block length equals the record length, no IRS character is required. The first IRS, ETX, or ETB (DLE ETB or DLE ETX in transparent text) of the first transmission block determines the record length for records in that data set. An IRS character preceding the ETX or ETB character is mandatory on all multiple record transmission blocks except the last block.

For the receive portion, up to 512 bytes per block can be received. Each record within the data set being received must be the same length. Records must be separated by IRS characters if more than one record per transmission block is to be received. Records can be spanned between two transmission blocks. Transmission block lengths must be greater than the length of each record, except for the last transmission block of the data set.

The receive operation can also receive one record per transmission block in either transparent or non-transparent text. When the transmission block length equals the record length, no IRS character is required.

The first IRS, ETX, or ETB (DLE ETB or DLE ETX in transparent text) character of the first transmission block determines the record length for records in that data set. IRS prior to ETX or ETB is mandatory for all multiple record blocks except the last block.

Receive Mode Example

Figure 38 illustrates an example of receive mode. In this example, one data set will be received. To prepare for receiving data, the operator inserts the diskette and selects receive mode. The 3741 is then ready to receive data.

Transmit/Receive Mode (B)

The transmit/receive mode of operation is used to transmit data and receive data without operator intervention. After loading the disk(s), an operator can place the 3741 in a transmit/receive mode by pressing FUNCT SEL upper, COMM, and B. A B will then be displayed on the display's status line to indicate the transmit/receive mode.

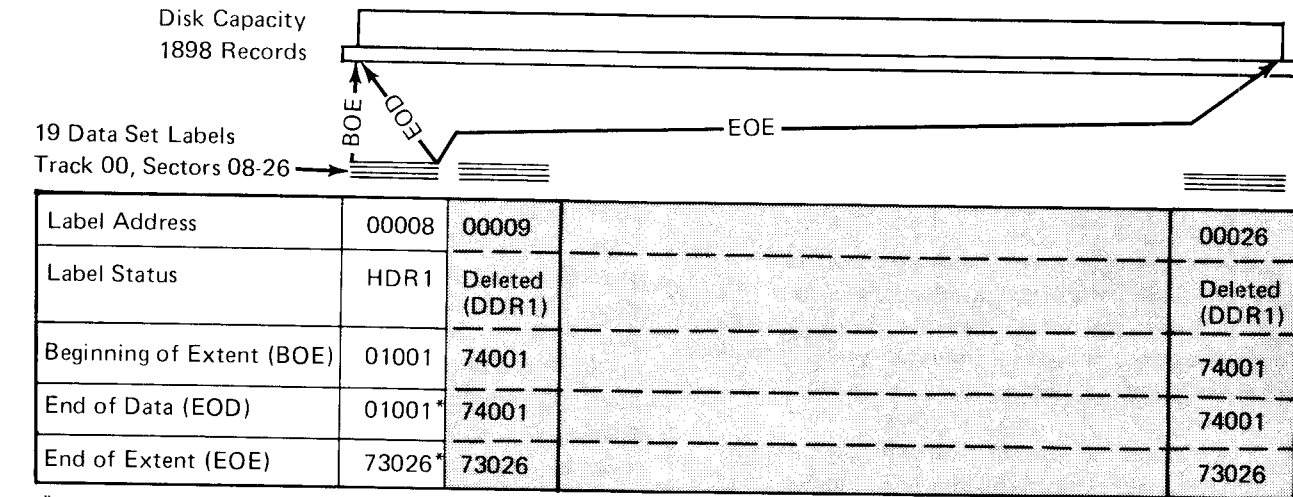

*These extents will be modified to appropriate addresses by the communications program (the addresses generated will depend on the amount of data received for the data set).

-----BEFORE RECEIVING DATA-----

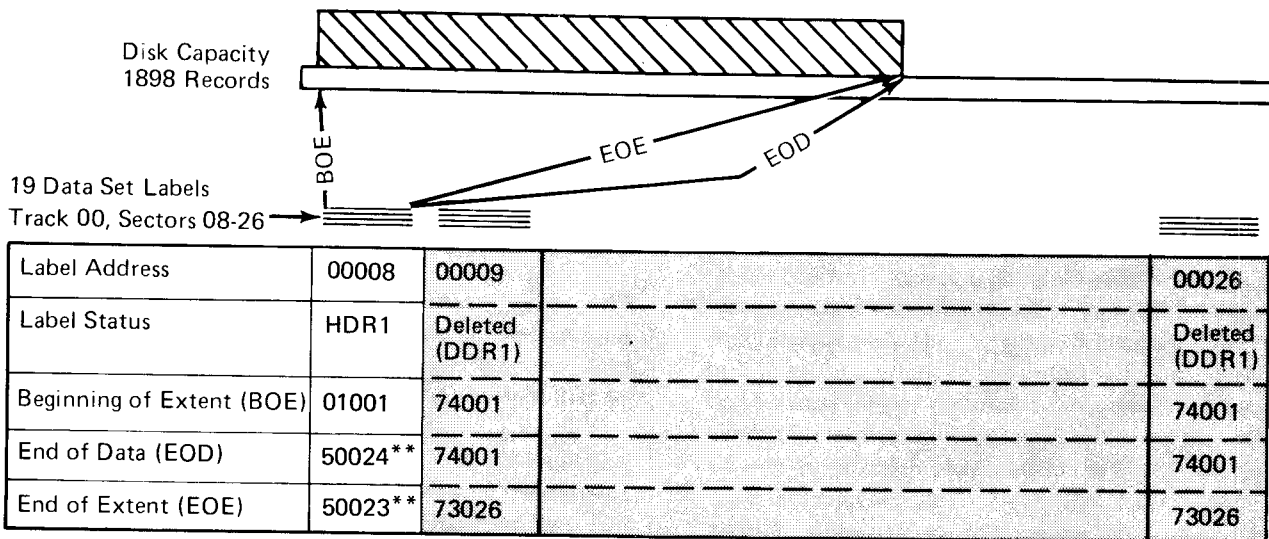

**Note the modified extent addresses.

-----AFTER RECEIVING DATA-----

Figure 38. Receive Mode Example

The 3741 can then be connected to the telephone line through a modem. When the connection has been made, data will be transmitted beginning with the first disk until all index positions of disk one have been interrogated for possible transmission. Only valid (HDR1) data set labels can be transmitted. Valid (HDR1) data set labels with a B (bypass) in position 41 are not transmitted. Data set labels that are deleted or invalid are not transmitted. A C in the multivolume indicator will allow transmitting the continuation of the data set on disk two. A BT is indicated in the mode indicator position on the display's status line indicating a completed transmission. The transmit/receive mode then switches to receive. Data is received into the first data set whose label qualifies for receiving data. For disk 1, a label qualifies for receiving data if it is a valid HDR1 label, has a B in the bypass field, and is after the last transmitted data set. For disk 2, a label qualifies for receiving data if it is a valid HDR1 label or a HDR1 label with a B in the bypass field.

For the first data set to be received, the beginning of extent of the data set's label is set to one more than the end of extent of the last data set transmitted unless the last EOE address is equal to 73026.

To transmit disk 1 and receive on disk 2, set EOE of the last data set transmitted on disk 1 to 73026.

The BOE of the first data set label on disk 2 is set to 01001 if transmission ends on disk 1.

Data can be received and recorded on the disks in the same or subsequent telephone call. (See Figure 39 for a summary of extents generated during the receive portion of the transmit/receive mode.)

When the 3741 has received all of the data transmitted to it, it will display BC to indicate a completed transmission and reception of data.

If a disk error or a transparency error has occurred during the transmission portion of this mode, the 3741 will indicate a BI in the mode indicator position of the display's status line. If a disk error or a disk full condition occurs during the receive portion of this mode of operation, a BJ is indicated in the mode indicator position of the display's status line. The operator must intervene to correct or bypass the error condition.

If the mode indicator remains B (as it would if a line check, remote abort, or message aborted error occurred), the 3741 will answer a phone call and will transmit the data beginning at the same place as the original call. However, on early shipments of the 3741 Model 2, if communications mode was selected with a data set record displayed, the operator must reposition the disk to the original starting position. Your 3741 can be field upgraded so that the operator does not have to reposition the disk to the original starting position. Contact your IBM representative for more information. If your 3741 has not been field upgraded and you are performing unattended operations, it is recommended that the communications mode be selected while the label is displayed. If the mode indicator remains BT (as it would if a line check, remote abort, or wrong length check occurred), the 3741 will answer a telephone call and will receive the data beginning at the receive mode start point.

The receiving of data can occur on the same or subsequent telephone call. The receiving of data can take place on the same telephone call only when the 3741 is in communication with a CPU.

	BOE	EOD	EOE
Succeeding data sets on first or second disk	Previous EOD	BOE + number of records received	EOD - 1 (if null data set, EOD)
First data set following a transmitted data set on first or second disk.	Previous EOE + 1	BOE + number of records received	EOD - 1 (if null data set, EOD)
First received data set on second disk if the transmit ended on disk 1.	01001	BOE + number of records received	EOD - 1 (if null data set, EOD)

Figure 39. Generated Extents while in Receive Portion of the Transmit/Receive Mode

In the expanded communications feature receive portion of the transmit/receive mode, the 3741 has the capability of receiving non-transparent transmission blocks containing up to 512 data bytes. Each record must be the same length within each data set. Records must be separated by IRS characters if more than one record per transmission block is to be received. Records can be spanned between two transmission blocks. Transmission block lengths must be greater than the length of each record, except for the last transmission block of the data set. One record per transmission block in either transparent or non-transparent text can also be received with the expanded communications feature. When the transmission block length equals the record length, no IRS character is required. The first IRS, ETX or ETB (DLE ETX or DLE ETB in transparent text) of the first transmission block determines the record length for records in that data set. An IRS character preceding the ETX or ETB character is mandatory on all multiple record transmission blocks except the last block.

Expanded Communications Transmit/Receive Mode (K)

The expanded communications feature transmit/receive mode (K) is similar to the transmit/receive mode (B) except that multiple records are transmitted in each transmission block. Each transmission block can contain up to 512 bytes of data. When the expanded communications feature transmit/receive mode is selected, a K is displayed in the status line. For the transmit portion, the last character of each record in the buffer is followed by an IRS (inter-record separator) character which defines the end of that record. Records are read from disk into the 512-byte buffer until a complete record and IRS character cannot be contained in the buffer. Thus, records are not spanned between transmission blocks.

The IRS and IFS (interfield separator) characters cannot be sent as data in the K mode of operation. If these or any other data link control characters are read from disk a transparency error will result. The IRS or IFS character can be transmitted in T, B, P, or D mode.

The operator identification card data is transmitted as a separate block without a following IRS character. The format of this block is described in the *IBM 3740 BTAM/TCAM Programmer's Guide*, GC21-5071.

Transmit-Transparent/Receive Mode (D)

The transmit-transparent/receive mode of operation is used to transmit data in the transparent mode and receive data without operator intervention.

After loading the disk(s), an operator can place the 3741 in a transmit-transparent/receive mode by pressing FUNCT SEL upper, COMM, and D. A D will then be displayed on the display's status line to indicate the transmit-transparent/receive mode.

This mode of operation is identical to the transmit/receive mode with the exception that data is transmitted in the transparent mode. DT, DI, DJ, and DC have meanings corresponding to BT, BI, BJ and BC in the transmit/receive mode.

Writing of Received Data Over Previously Transmitted Data

It is possible on the 3741 Model 2 or 4 in transmit/receive mode to transmit data, and then receive data and write the data over the same space on the disk. Before using the following technique, be sure that there is no requirement to keep the data that was transmitted to another location.

Since the technique used for transmit/receive mode is to start writing received data in the next available sector past the EOE of the last data set transmitted, it is possible to write received data over a portion of the disk from which data was previously transmitted. This can be done by transmitting as the last data set a null (empty) data set with the BOE, EOD, and EOE set to the desired address where you want the received data to be written on the disk.

On a 3741 Model 2 or 4 with two disk drives, the preceding procedure can be used to transmit one full disk of data and then receive 1897 records on disk 1 and 1898 records on disk 2. Disk 1 can contain only 1897 records since received records are written to disk starting at EOE+1. Thus if EOE is 01001, received records are written to disk starting at 01002.

Transmit/Receive Mode Examples

Figure 40 shows the transmitting of one data set (the data set identified by the data set label at 00008) and then the receiving of one data set on the same diskette. (The received data will be placed into the data set starting at EOE + 1 address for the data set defined by the data set

label at 00008.) In this example, the operator inserts the diskette and selects the transmit/receive communications mode.

Note: To receive data on disk 1, the data set label following the last transmitted data set must have a B (bypass) in position 41 in order to receive data.

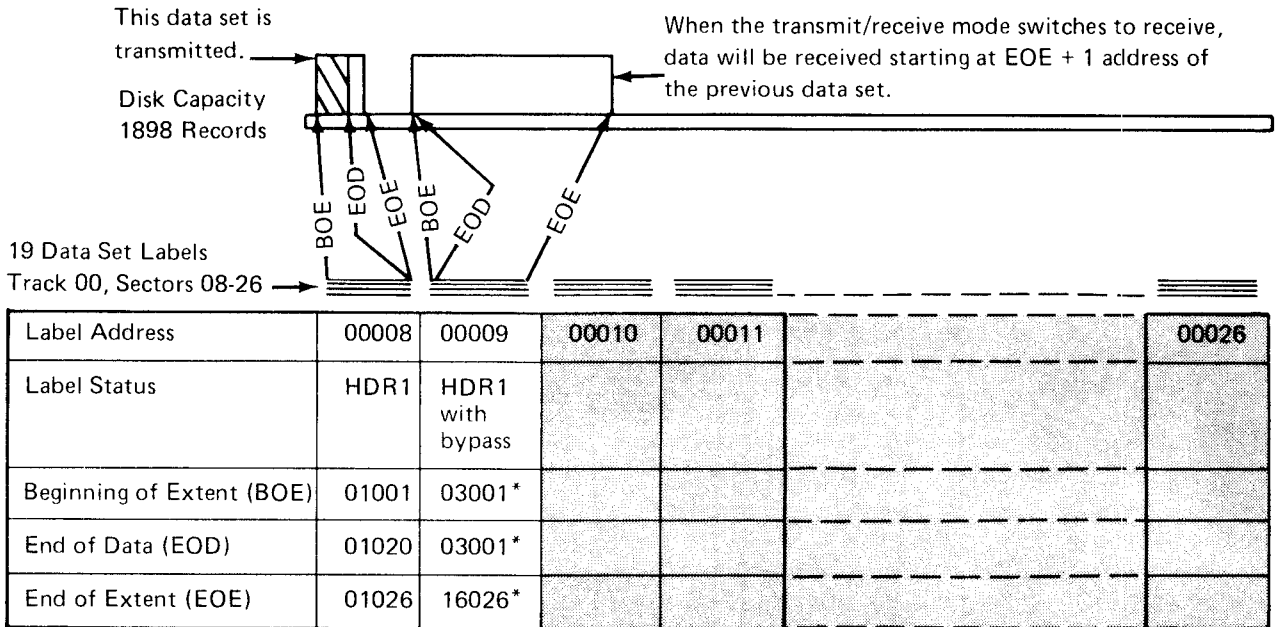

*These extents will be modified to appropriate addresses by the communications program (the addresses generated will depend on the amount of data received).

-----BEFORE RECEIVING DATA-----

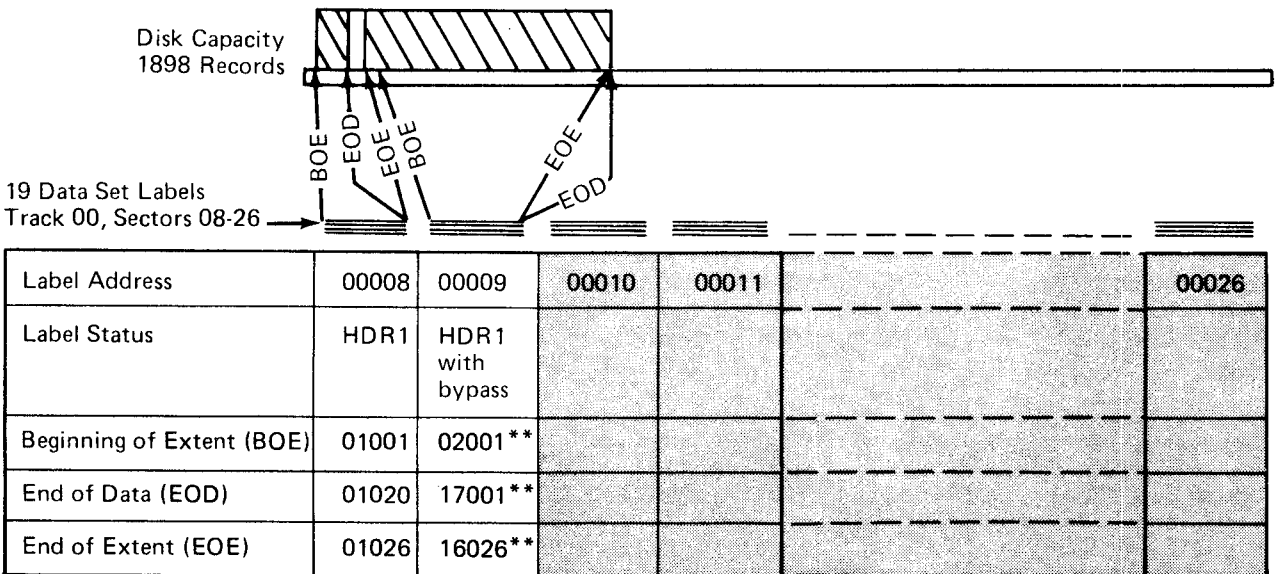

**Note the modified extent addresses.

-----AFTER RECEIVING DATA-----

Figure 40. Transmit/Receive Mode Example

Figure 41 illustrates the status of a disk on a single disk drive 3741 Model 2 or 4 before teleprocessing is initiated. In this example, two key-entry data sets are to be transmitted to the remote processing unit and two additional data sets are to be received from the processing unit. Disk labels 00011 and 00012 have been set up (via bypass status) to be used for receiving these data sets.

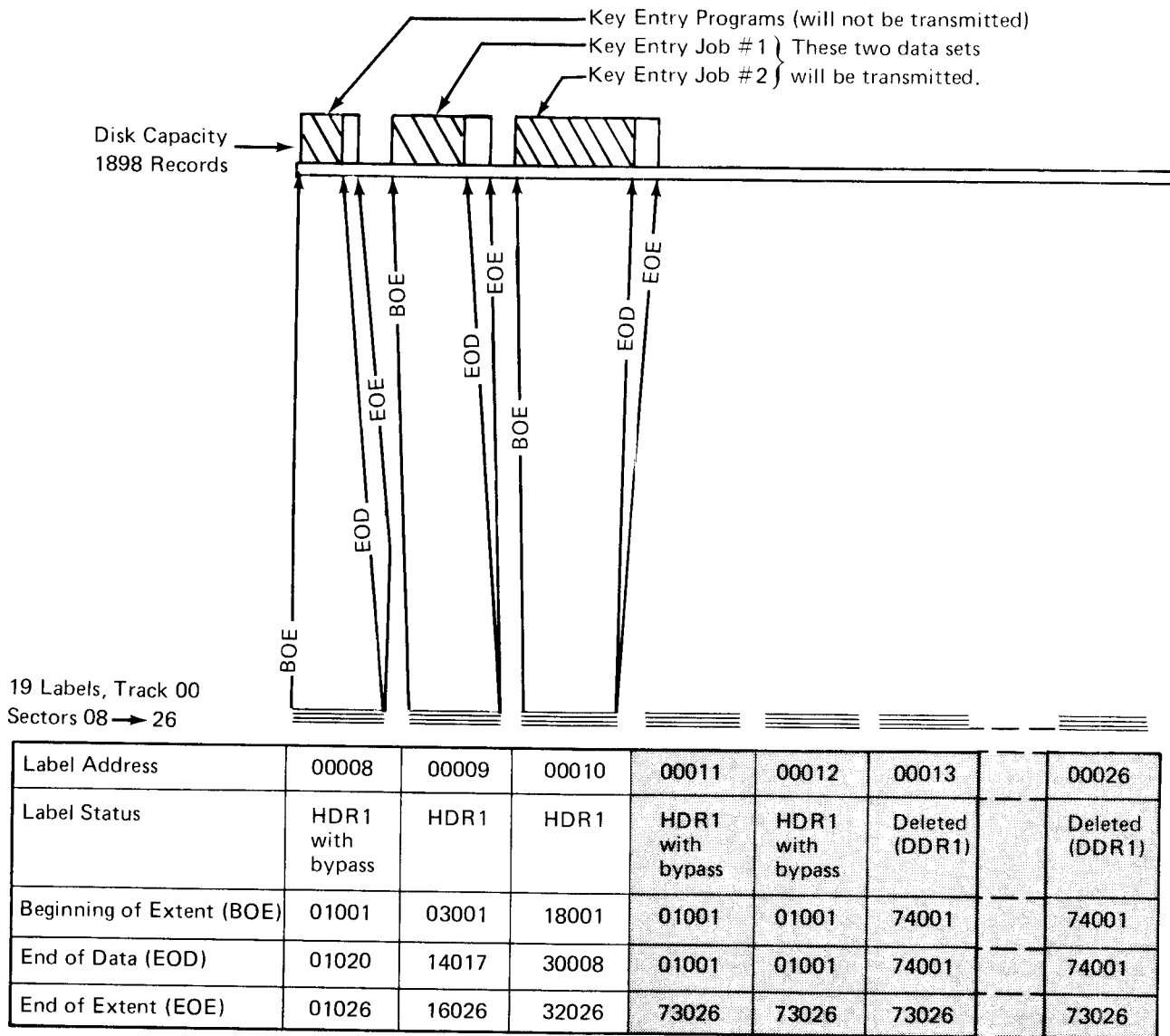

Figure 41. BSC Transmit/Receive Example (Before Teleprocessing Initiated)

Figure 42 illustrates the status of the disk after the transmit/receive mode teleprocessing function was completed. Note that key entry programs (for example) may be stored on the disk without being affected by teleprocessing.

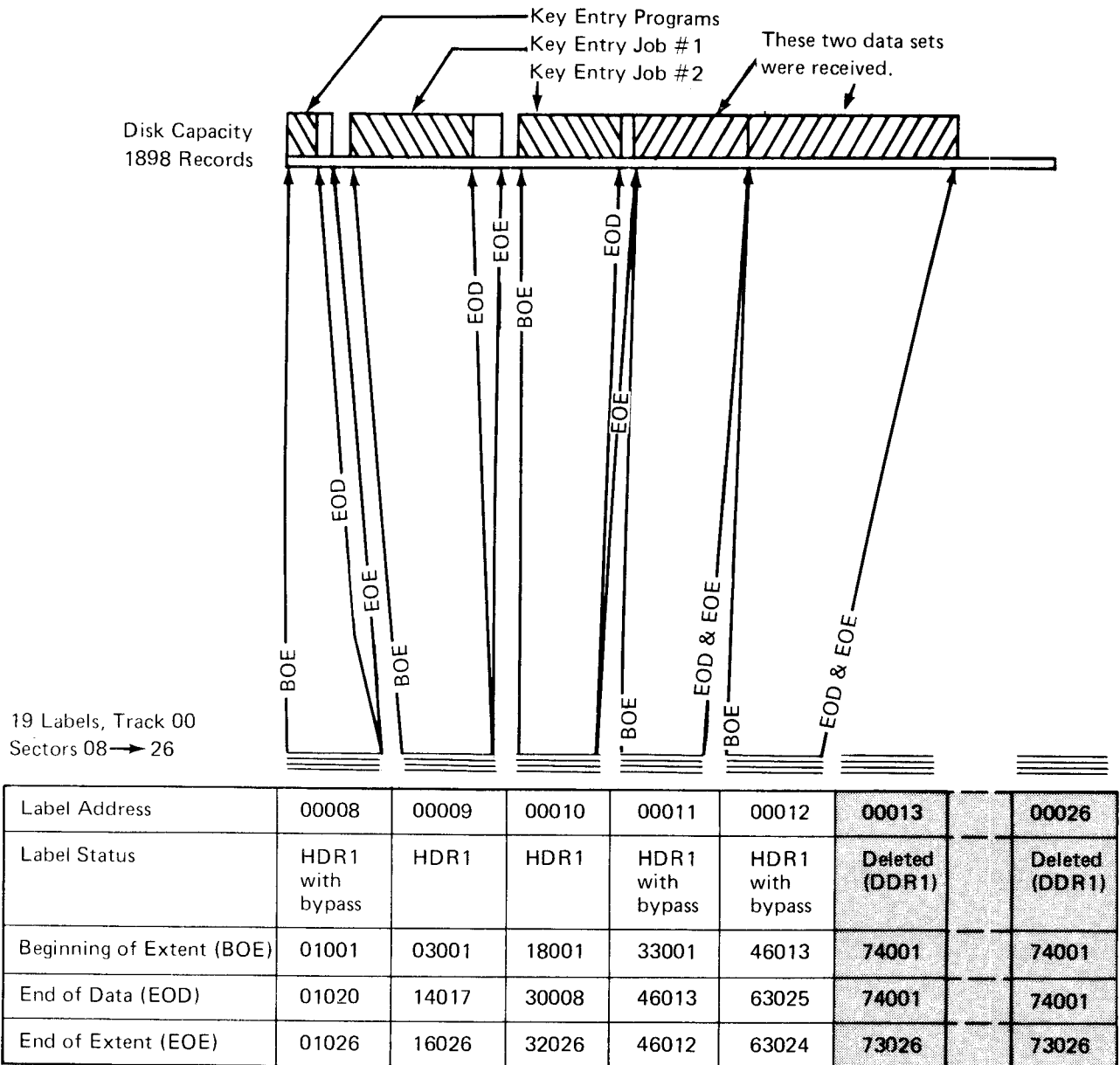

Figure 42. BSC Transmit/Receive Example (After Teleprocessing Completed)

Inquiry Mode (I)

Inquiry mode can be selected from read index mode when on a valid data set label or from update mode when on a valid data set record. The record length for the data set must be 128. After inquiry mode is selected, the mode indicator on the display shows an "I" if the operator identification card reader is not installed. The display shows "IB" if the operator identification card reader is installed. The display portion of the display is blank. After selecting inquiry mode, the operator can key an inquiry record of up to 128 characters. If the operator selected inquiry mode from read index mode, the operator keys the entire inquiry message. If the operator selected inquiry mode from update mode, the operator may choose to record backspace or record advance to a previous inquiry message and modify that message to create a new inquiry message.

All data shown on the display (up to the last non-blank) is transmitted to the processing unit when the operator pressed FUNCT SEL upper and S. If inquiry mode as selected from read index mode, the inquiry record is written at the BOE address of the data set. If inquiry mode was selected from update mode, the inquiry message is written at the EOD address of the data set.

Responses to the inquiry record are written on disk starting at the address following the transmitted inquiry message. After all responses are received, the first response received is displayed to the operator. The operator may record advance or record backspace to display any record in the data set. All records (both inquiry and response) are written on disk with a record length of 128, and are padded with blanks, if necessary.

After receiving the responses to an inquiry record, the operator can then send another inquiry record if required. The inquiry message would be written to disk at the disk address following the last received response record. FUNCT SEL upper and I will blank the display screen.

The EOD address is updated after receiving all responses to the inquiry message (IC mode). The EOE is updated to EOD-1.

Notes:

1. If an error occurs while trying to transmit an inquiry message, the EOD is not updated, except when line check and data set not ready (errors C and I respectively) occur.
2. If an error occurs while receiving responses, the EOD is always updated, except when disk errors or wrong length check (W) errors occur.

Binary Synchronous Communications Summary

Figure 43 summarizes the functional capabilities of binary synchronous communications for the 3741 Models 2 and 4.

Function	Mode							
	R	T	P	B	D	J	K	I
Transmit:								
Non-transparent Data	N/A	Yes	No	Yes	No	Yes	Yes	Yes
Transparent Data	N/A	No	Yes	No	Yes	No	No	No
Record Length	N/A	≤128	≤128	≤128	≤128	≤128	≤128	=128*
Block Length	N/A	≤128	≤128	≤128	≤128	≤512**	≤512**	≤128
Records Per Block-	N/A	1	1	1	1	>1	>1	1
Selected Records	N/A	No	No	No	No	Yes	Yes	No
Selected Fields	N/A	No	No	No	No	Yes	Yes	No
From Two Disks	N/A	Yes	Yes	Yes	Yes	Yes	Yes	No
Multiple Data Sets	N/A	Yes	Yes	Yes	Yes	Yes	Yes	No
Receive:								
Non-transparent Data	Yes	N/A	N/A	Yes	Yes	N/A	Yes	Yes
Transparent Data	Yes	N/A	N/A	Yes	Yes	N/A	Yes	Yes
Record Length	≤128	N/A	N/A	≤128	≤128	N/A	≤128	=128*
Block Length Excluding IRS Characters	≤512**	N/A	N/A	≤512**	≤512**	N/A	≤512	≤512
Records Per Block	≥1	N/A	N/A	≥1	≥1	N/A	≥1	≥1
Selected Fields	Yes	N/A	N/A	Yes	Yes	N/A	Yes	N/A
On Two Disks	Yes	N/A	N/A	Yes	Yes	N/A	Yes	N/A
Multiple Data Sets	Yes	N/A	N/A	Yes	Yes	N/A	Yes	N/A
Print After Receive:								
No Format Control	Yes	N/A	N/A	Yes	Yes	N/A	Yes	N/A
Data Stream Format	Yes	N/A	N/A	Yes	Yes	N/A	Yes	N/A
Manual Format Select	Yes	N/A	N/A	Yes	Yes	N/A	Yes	N/A
Record Format Select	Yes	N/A	N/A	Yes	Yes	N/A	Yes	N/A
N/A = Not applicable								
*Records written to disk are always 128 characters. (If less than 128 characters are received, the record is padded with blanks.)								
**Systems without the EBCSA feature can only transmit and receive block lengths up to 128 characters.								

Figure 43. Binary Synchronous Communications Summary

OPERATING PROCEDURES

Figure 44 provides a general operator procedure overview for communications except for inquiry. Figure 45 provides a general operator procedure overview for inquiry mode.

Figure 46 illustrates the status indicators displayed on the CRT display status line during BSCA operation.

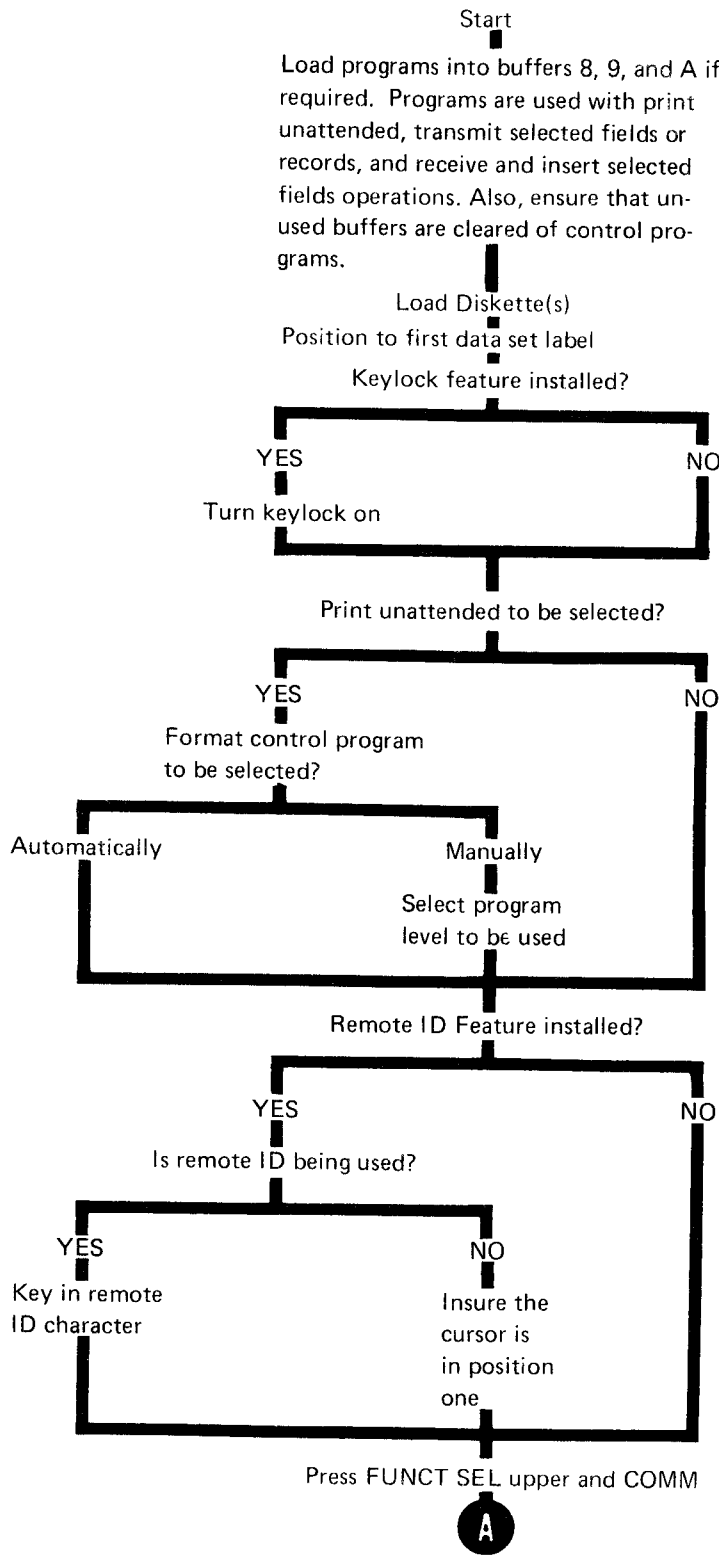

Figure 44 (Part 1 of 5). General Operator Procedure Overview

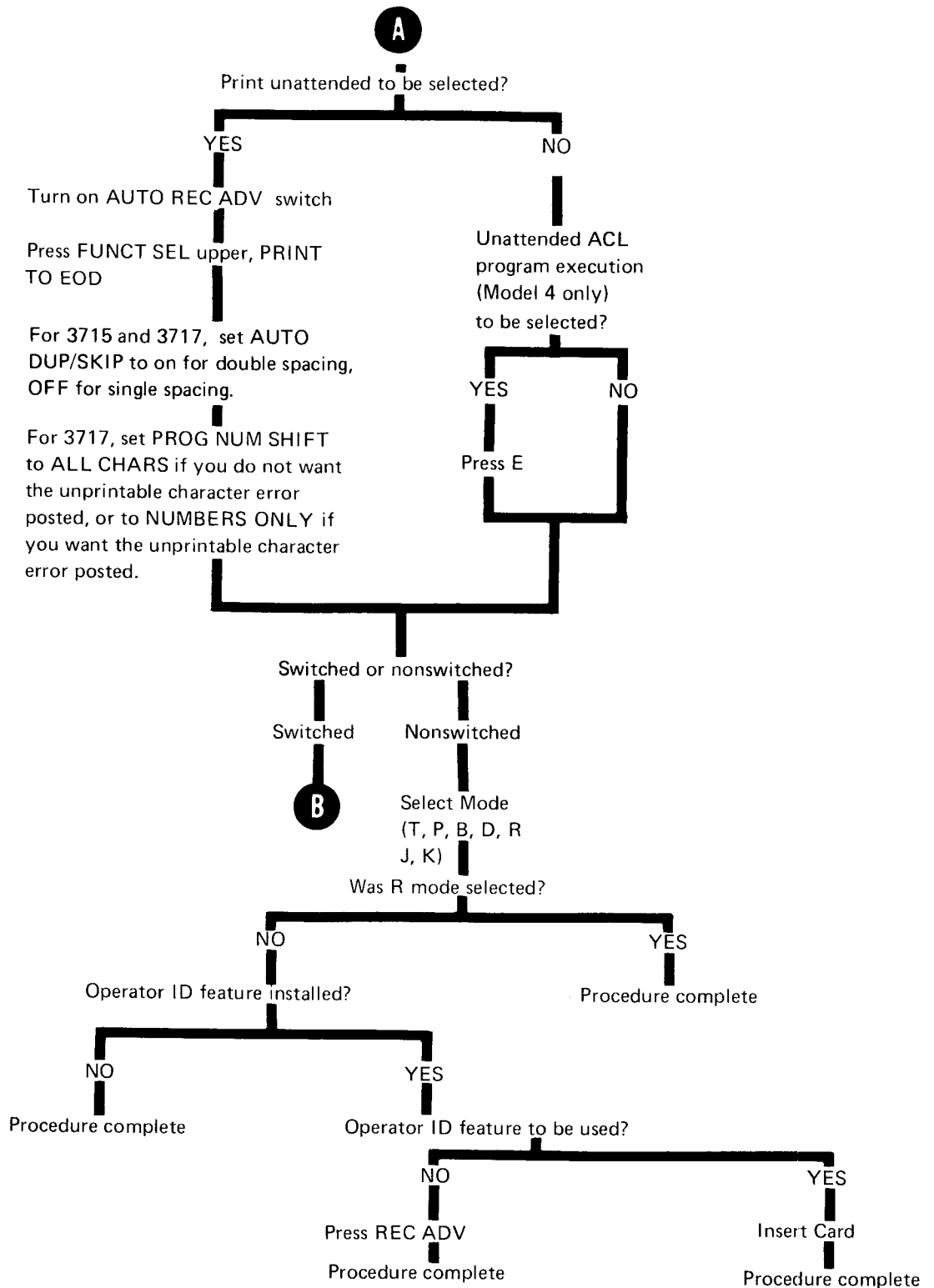
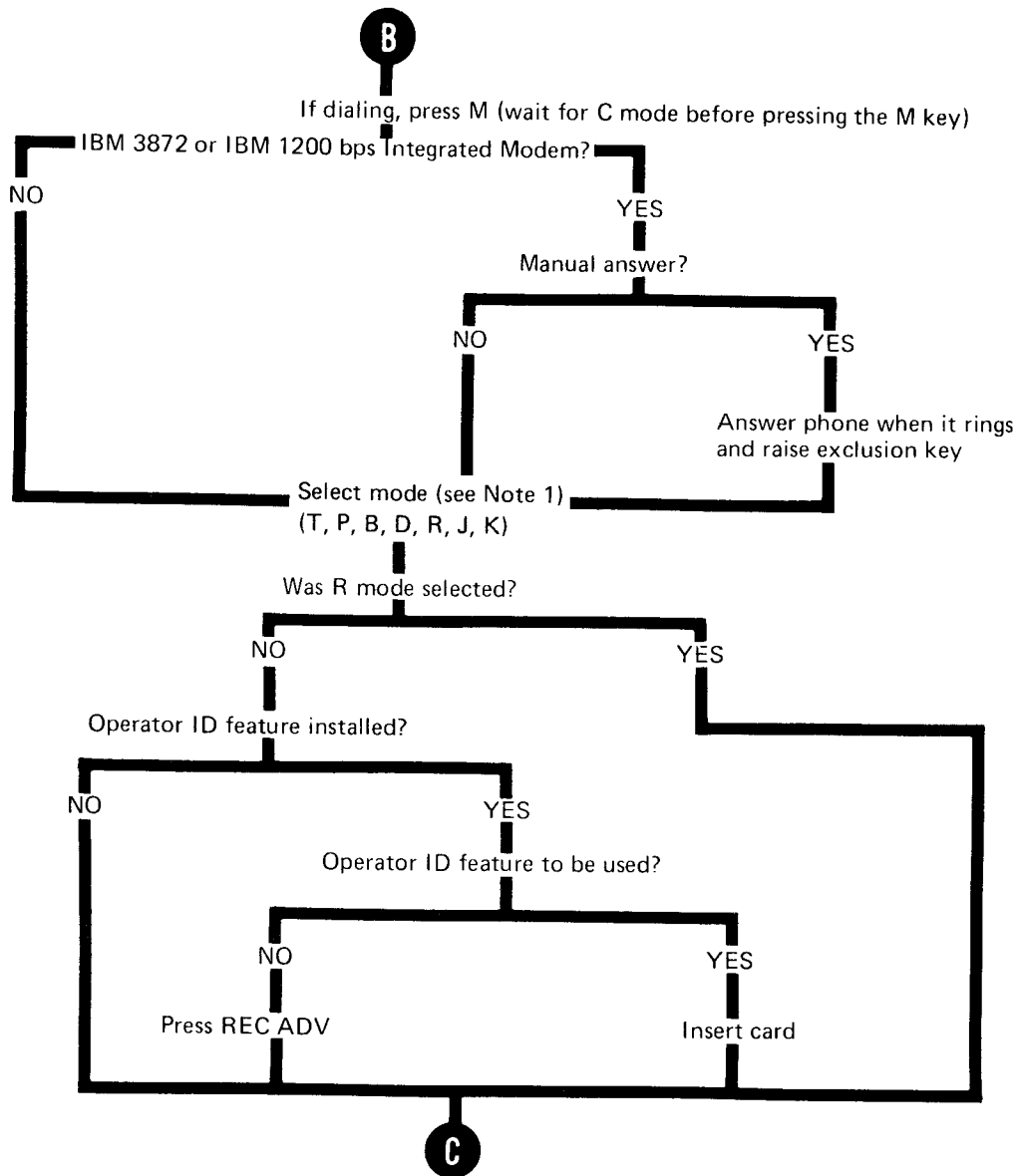
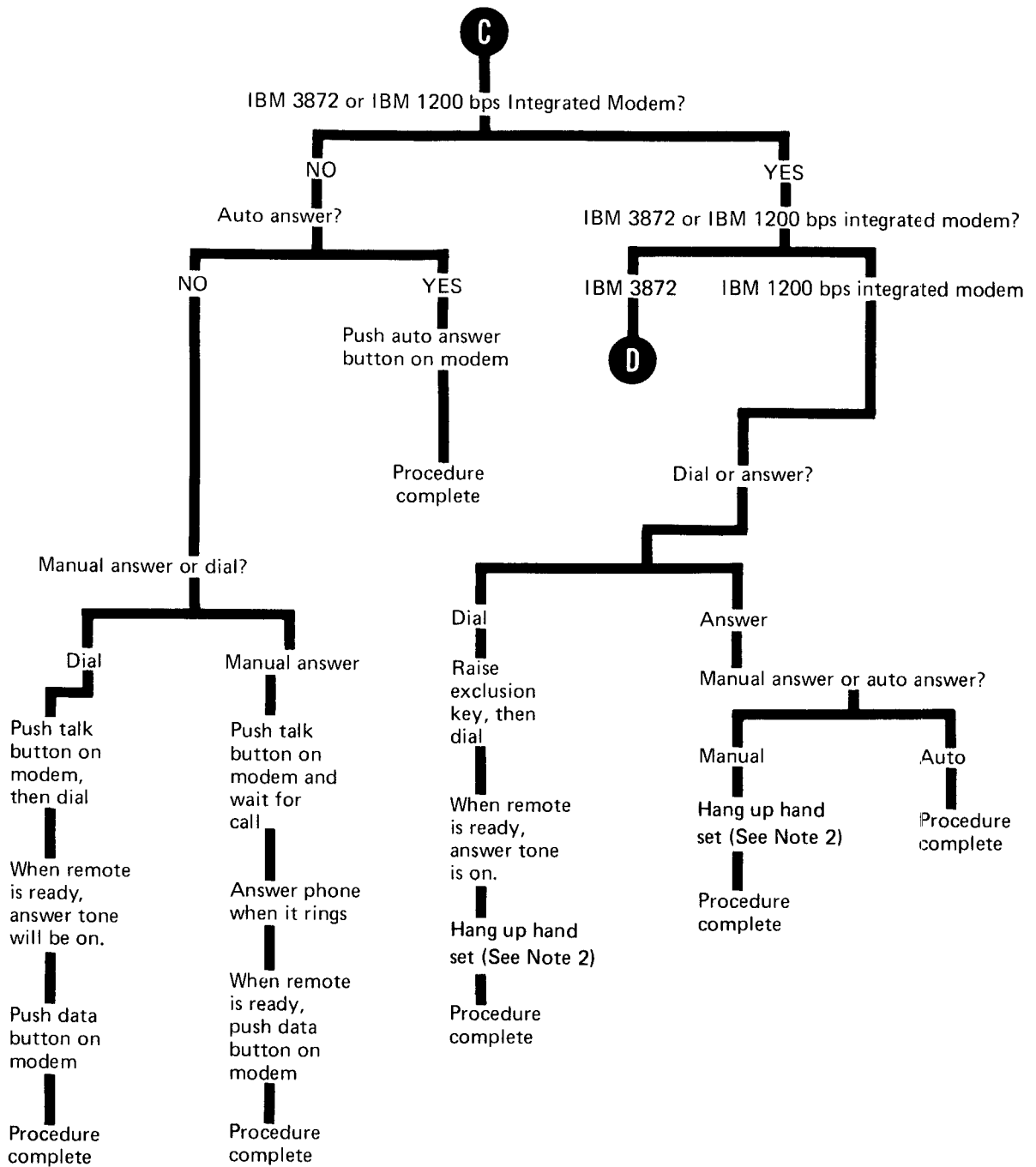

Figure 44 (Part 2 of 5). General Operator Procedure Overview



Note 1: If WT PSN 1200 bps Integrated Modem, except for Auto Answer, do not select mode until the remote terminal is ready.

Figure 44 (Part 3 of 5). General Operator Procedure Overview



Note 2: Do not hang up until status is displayed on line 6 of the CRT display (see Figure 47).

Figure 44 (Part 4 of 5). General Operator Procedure Overview

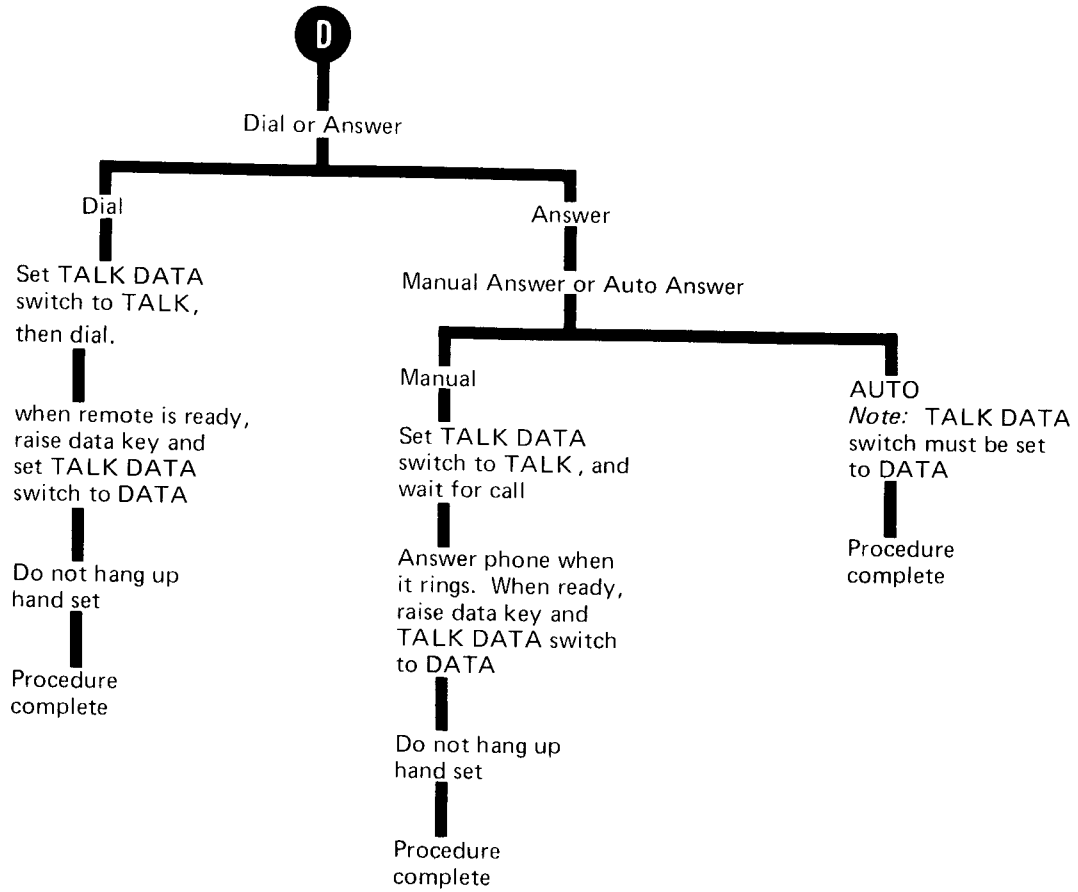

Figure 44. (Part 5 of 5) General Operator Procedure Overview

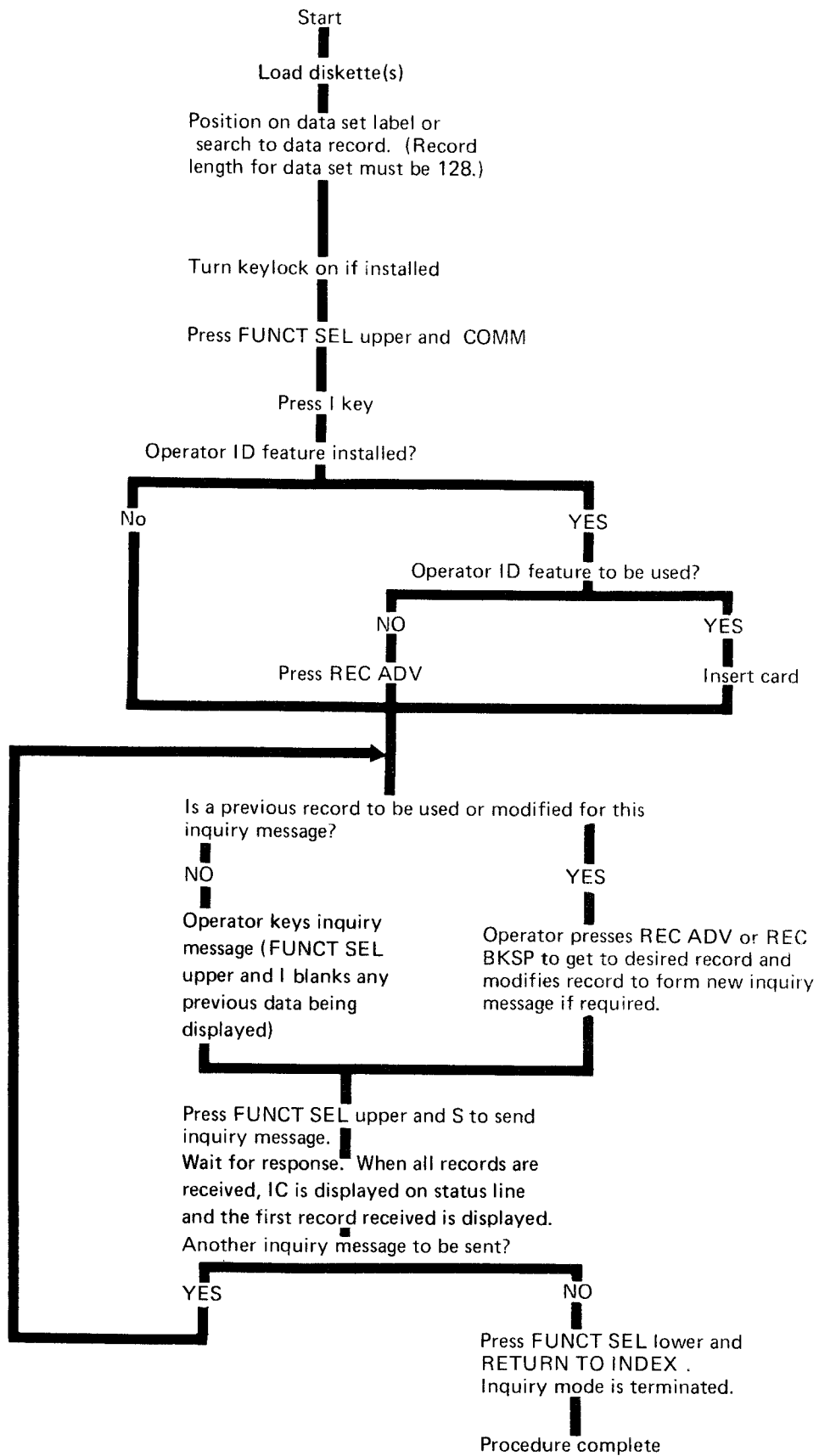
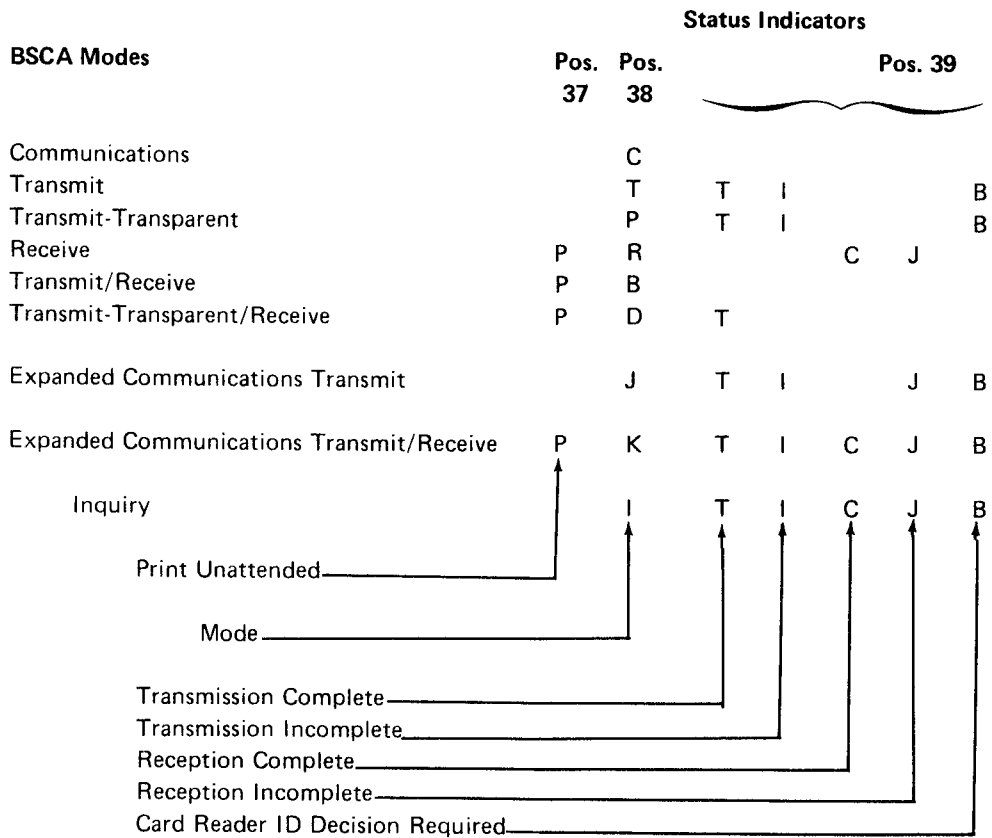

Figure 45. Inquiry Operator Procedure Overview



Note: During BSC operations, line 6 of the CRT displays diagnostic information that is used by the Customer Engineer during trouble calls. See *BSC CE Status Line* for more information.

Figure 46. Status Indicators on Status Line of CRT Display during BSCA Operations

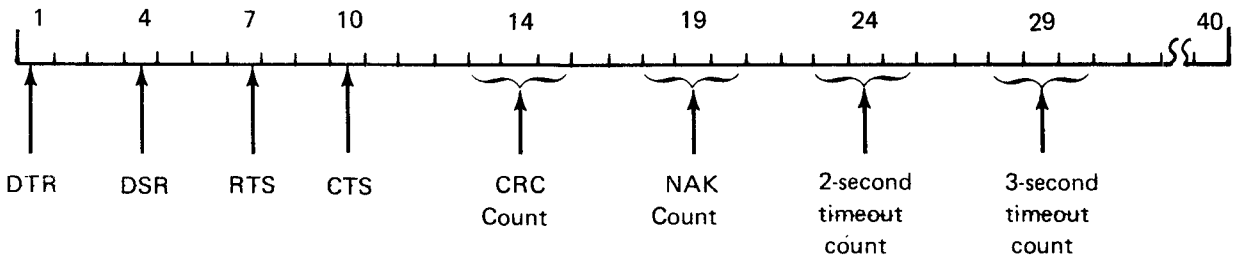

Figure 47. BSC CE Status Line

LINE TERMINATION AND ERROR CONDITIONS

The following sections describe line termination of a call, BSCA error conditions and indicators, and BSCA disk errors that can occur during teleprocessing, and what the disk address and the record displayed mean when a teleprocessing error occurs. The section, *Error Recovery Procedures*, provides information on how the operator can restart the communications mode when an error stops the teleprocessing.

Termination of the Data Call

On switched lines, a data call is terminated when a disconnect sequence is received, when a disconnect timeout occurs, or when RESET is pressed. Pressing RESET takes the 3741 out of a communications mode of operation. The end of data and end of extent are updated (see Figure 37 or 39) under the following conditions:

- if a disconnect sequence is received and either:
 1. The mode is R, RC, BT, BC, DT, DC, KC, or KT.
 2. The mode is RJ, BJ, KJ, or DJ; and a disk full error has occurred.
- If a disconnect timeout has occurred and either:
 1. The mode is R, RC, BT, BC, DT, DC, KC, or KT.
 2. The mode is RJ, BJ, KJ, or DJ; and a disk full error has occurred.

If the mode is T, P, R, B, D, J, KT, BT, or DT, the disk is positioned at the original position before transmission or reception took place, and the modem is conditioned to automatically answer a telephone call if it is in an auto answer mode. If the mode is TT, TI, PT, PI, RC, RJ, BI, BJ, BC, DI, DJ, DC, JT, JI, KC, KI, or KJ, the modem is not conditioned to answer a telephone call.

Inquiry Mode Termination

The operator can terminate inquiry mode by pressing FUNCT SEL lower and RETURN TO INDEX, thus causing the data set label in position 00008 to be displayed.

BSCA Error Conditions and Indications

Characters in parentheses indicate what is displayed in the error indicator position of the display's status line.

Transparency Check (T)

This error condition occurs when the 3741 is in a transmit (J, T) or a transmit/receive, (B, K) mode, and one of the following characters is read from disk: SYN, EOT, DLE, NAK, ENQ, ETB, ETX, ITB, STX, or SOH. The 3741 sends ENQ in place of the data link control character, and then follows the response with an EOT. This error also occurs when the 3741 with expanded communications is in the J or K mode, and an IRS or IFS character is read from disk. The 3741 sends ENQ in place of the data link control character, and then follows the response with an EOT.

Line Check (C)

A line check occurs when seven receive timeouts or 15 line bid timeouts on a switch network have occurred during the transmitting or receiving of data. If the 3741 is on switched lines, it disconnects from the line. If the terminal is on nonswitched lines, it goes into a control mode, monitoring the line for line bids.

Remote Abort (R)

A remote abort occurs when an EOT or a disconnect sequence is received as a response to a data transmission block, or following a response sent after receiving a data transmission block that did not end with ETX.

On nonswitched or switched lines, an EOT causes the 3741 to go into control mode, monitoring for line bids. On switched lines, a disconnect sequence or a disconnect timeout causes the 3741 to disconnect from the telephone line.

Message Aborted (Q)

A message aborted condition occurs after four consecutive negative responses have been received as responses to the same data transmission block. The 3741 sends an EOT following the fourth negative response.

Received Line Bid (V)

When the 3741 receives a line bid while in one of the following point-to-point communications modes; RC, TT, PT, BC, DC, JT, KC, RJ, BJ, TI, BI, DI, PI, JJ, KJ, or KI, the 3741 responds with a negative response (NAK) and gives a received line bid indication.

Wrong-Length Check (W)

Whenever the 3741 has received the first data block of a data set with zero characters or with more than 128 characters, or has received succeeding data blocks of different length within the same data set, or when communications mode is selected from update mode and receive data length is not equal to the record length specified in the data set label, the terminal indicates a wrong-length check and transmits an EOT as a response to the data block.

This error also occurs when the number of characters received does not equal the number of greater than (>) sign characters in the receive data and insert constants program or when a continued data set on disk 2 has a different record length than the data set on disk 1.

Negative Bid Response (X)

Whenever the 3741 receives a negative response or disconnect sequence as a response to a transmitted line bid, the terminal indicates a negative bid response.

BSCA Disk Errors

If any of the following disk errors occur when the 3741 is transmitting or receiving data, it will abort by transmitting an EOT:

- Read
- Write
- Length
- Seek
- No record found

BSCA Setup Error (H)

This error condition results when the communications mode is selected and one of the following conditions exist:

- The terminal ID feature is installed and the cursor is positioned past column 16 of the current record buffer.
- The keylock is locked.
- BOE address of the first data set to be received is greater than 73026.
- Communications mode selected from update mode and the current disk address is greater than 73026.

- Receive mode is selected from update mode and the record length of the receive data and insert constants program does not match the record length of the current data set.
- Transmit mode (T, P, J, or I) is selected after the print unattended function has been selected.
- Unattended print function selected and the AUTO REC ADV switch is not set to ON.
- Inquiry mode is selected and the record length of the current data set is not equal to 128.
- Selected inquiry mode from update mode and the EOD address is greater than 73026.
- Selected both unattended ACL program execution and unattended print.

BSCA Disk(s) Full (D)

This error results from one of the following conditions:

- Whenever all available record positions have been recorded into. On early shipments of the 3741 Model 2, this will occur when receiving from another terminal and the last received record is recorded in 73026 even though there may be no more records to be received. Your 3741 can be field upgraded so that this error does not occur when the last record received is recorded in 73026. Contact your IBM representative for more information.
- Whenever no valid data set labels exist to receive into.
- Whenever the last data set of the transmission is transmitted and a continued data set is indicated.
- Whenever, in inquiry mode, the last received response is written in location 73026 of disk one, or if the received responses being written overflow onto disk two.

Data Set (Modem) Not Ready (I)

Whenever the 3741 detects that the data set ready status has been lost after initially having ready status, the terminal indicates a data set not ready error.

Operator Initiated Termination (S)

Whenever the reset key is used to terminate a BSCA operation, an S is displayed temporarily while the 3741 is transmitting a status message.

BSCA Received Data Block (U)

This error results when a remote station sends a data block where an acknowledgement is required and the 3741 is in a transmit mode.

Write Protect Error (G)

This error occurs when the first label of either disk, that is made available for a receive operation, is write protected. On early shipments of the 3741, the write protect error conditions were not detected during communications. Your 3741 can be field upgraded so that the error condition can be detected. Contact your IBM representative for more information.

Unattended Print Setup Error (B)

This error occurs when using the 3713 unattended print function and the first data set received is on disk 2. The teleprocessing is complete and the 3741 is in print (P) mode when the error indicator is displayed.

Note: Sector 7 of disk 1 is displayed with the error indicator.

Multiple Network Audible Alarm

This alarm beeps when the host processing unit is attempting to transmit data to a 3741, which is not set up in a Communication (Receive) Mode. If the 3741 is to receive data, it should be set up in Receive Mode.

Track and Sector Indicators

The track and sector number indicator on the display's status line has the following meanings:

Modes .	Indicates Address Position of:
T, B, P, D, J, K	Next record after the last acknowledged record transmitted.
TT, PT, JT	00026 or, if the last data set was continued, the last record transmitted from disk 1. Always 00026 on disk 2.
R, BT, DT, KT	Next record after the last acknowledged record received.
R, BT, DT, KT with remote abort error condition	Label of the last data set received.
RJ, BJ, DJ, KJ with disk full error	Label of the last data set received if the remote terminal is a 3741 or a 3747.
	Label of the last data set received or next valid label if the remote device is a processing unit.
R, BT, DT, KT with wrong-length check or TI, RJ, BI, BJ, PI, DI, DJ, KI, KJ, JI	Record in which the error occurred.
RC, BC, DC	Next available valid label if remote device is a 3741 or 3747.
	Label of last data set received or next valid label if remote device is a processing unit.
I	Next record after the address where the inquiry message was written to disk. The data lines on the display are blank.
IT	Next record after the address where the inquiry message was written to disk. The data lines on the display are blank and the appropriate error is displayed.
IC	Next record after the address where the inquiry message was written to disk. The data lines show the first received response to an inquiry message.

Status Message Format

A status message is sent to the remote station after the 3741 has responded negatively to a remote station's line bit request, or responded negatively to a multipoint select, or after the 3741 has prematurely terminated a transmission or reception of a message. In transmit mode (T, P, B, J, K, I, or D), this occurs when a transparency check, disk error, line check, received data block error, disk full error, disk accessibility, incorrect data set label, or message aborted (after transmitting a block four times) condition has been encountered. In receive mode (R, BT, KT, IT, or DT) this occurs when a wrong length check, disk(s) full, line check, disk accessibility, write protect, or disk error condition is encountered. Also, a status message is sent when RESET is used to abort the transmission or reception of data. The 3741 will attempt to send status on a point-to-point network. On a multipoint network, the control station must poll for the status message.

The status message is sent with the following line control format:

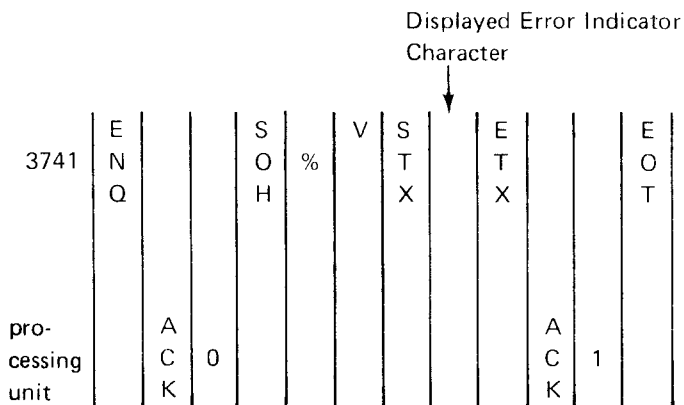

Note: On multipoint networks, an additional error indicator character, a slash (/) can be sent with a status message. This error indicator character is sent when the 3741 is selected but is not ready. However, the slash (/) is not displayed on the status line as are the other error indicator characters.

BSC CE Status Line

The BSC CE status line, primarily for use by customer engineers, appears whenever a communications mode is selected. The BSC CE status line is on line 6 of the display. The information displayed indicates the following conditions:

- Data terminal (3741) ready (DTR)
- Data set (modem) ready (DSR)
- Request to send (RTS)

- Clear to send (CTS)
- Number of incorrect CRC's in receive mode
- Number of NAK's sent in transmit mode
- Number of two-second timeouts
- Number of three-second timeouts

Figure 47 shows the format of the BSC CE status line.

For the DTR, DSR, RTS, and CTS positions, either a zero (0), indicating the condition is not present, or a one (1), indicating the condition is present, is displayed.

The four counters, CRC, NAK, 2-second timeout, and 3-second timeout, are three position counters that are incremented each time the condition occurs.

Error Recovery Procedures

There are several different types of errors that can occur:

1. Errors for which there is no error indication to the operator and from which the 3741 can automatically recover. An example is when a read error occurs and the 3741 retries the read and the operation is successful. (The 3741 retries read errors 11 times before displaying an error to the operator.)
2. Errors for which there is an error indication to the operator (but no operator intervention is required) and errors from which the 3741 can automatically recover. (This type of automatic error recovery is only available on switched networks.) An example of this type of error is the remote abort error. When this type of error occurs, the 3741 will answer a telephone call and either transmit or receive data beginning at the same place as the original call. However, if the transmit/receive mode was selected, and the error condition occurred during the receive mode, the 3741 will answer a telephone call and receive the data beginning at the receive mode start point.
3. Errors that occur when using the 3713 unattended print function while the first data set received is on disk 2. The following section explains the operator error recovery procedures.

When this error occurs, the teleprocessing is complete, but the data set is not printed. To print the data set, the operator must perform the following:

- a. Place the disk in the first disk drive.
 - b. Record advance (if necessary) to the data set label for the data set you want to print.
 - c. Turn the AUTO REC ADV switch on.
 - d. Press FUNCT SEL upper and PRINT TO EOD.
4. Errors for which there is an error indication to the operator and the 3741 cannot perform automatic recovery (unrecoverable communication errors). The following sections provide information on operator error recovery procedures for unrecoverable communications errors (those errors that the 3741 cannot automatically perform error recovery).

After an unrecoverable communications error (operator intervention required) has occurred, the 3741 Models 2 and 4 have the ability to restart the communications mode under operator control. The operator can restart the communications operation from:

- The beginning of the communications operation.
- The beginning of a data set.
- Any point within a data set.

When an unrecoverable communications error occurs the operator can examine records in the data set to determine the record location at the time of the error. Then, through mutual agreement with the far end location (either through earlier agreed upon procedures, or by direct voice contact) the communications can be restarted from the beginning of the communications operation, from the beginning of the data set, or from any point within the data set, depending on the limitations of the device at the far end location.

For example, if receiving when an unrecoverable communications error occurs, the data set label of the last data set being received is displayed on the CRT display. The operator could use the search EOD operation to determine the last record received before the error occurred. When the record is displayed, the operator can inform the transmitting location (through talk mode) of the last record received and begin the communication from any desired point.

If transmitting data when an unrecoverable communication error occurs, the record address after the last acknowledged transmitted record is displayed on the CRT display. The operator can inform the receiving location of the record not transmitted and begin transmitting from any desired point.

See *Track and Sector Indicators* in this chapter for information on the exact condition displayed when an error occurs.

Communications Throughput

Figures 48 and 49 show typical throughput rates for the 3741 Models 2 and 4 with and without the expanded communications feature or with the expanded communications/multipoint feature, respectively. The figures show throughput rates in terms of the number of records per minute processed as a function of record size, line facility, and modem speed. The rates listed are for information only.

The assumptions made in determining the throughput rates are:

- Setup and line initialization sequences are not included in determining the throughput rates.
- Non-transparent data is transmitted or received.
- Disk sequence is 01.
- No deleted records or disk errors are encountered.

- No retransmissions.
- Propagation delay and processing unit delay are negligible.
- Speed of remote device is equal to or faster than the 3741.
- For two-wire lines, the 1200, 2000 and 2400 bps modems have 200, 175, and 180 millisecond clear-to-send delays, respectively.
- For four-wire lines, the 1200 and 2400 bps modems have 25 and 85 milliseconds clear-to-send delays, respectively.
- For figure 48 a transmit selected records program was not used.

In Figures 48 and 49, the use of System/3 LCA has the equivalent throughput of the 2400 bps four-wire line.

Characters Per Record	Records/Minute						
	2400 bps			2000 bps	1200 bps		
	Nonswitched*		Switched**	Switched	Nonswitched*		Switched**
	Transmit	Receive	Transmit or Receive	Transmit or Receive	Transmit	Receive	Transmit or Receive
20	345	175	110	105	180	170	85
40	260	175	100	90	130	115	70
60	200	175	90	80	100	85	60
80	160	115	80	70	80	75	55
100	135	115	75	65	65	65	45
120	115	115	70	60	55	55	40
128	110	100	65	55	55	55	40

* Full duplex facility or four wire switched network

** Two wire switched or nonswitched half-duplex facility

Figure 48. Communication Throughput Rates for the 3741 Models 2 and 4 without the Expanded Communications Features

Characters Per Record	Records Per Block	Records Per Minute									
		2400 bps				2000 bps		1200 bps			
		Nonswitched*		Switched**		Switched		Nonswitched*		Switched**	
		Transmit	Receive	Transmit	Receive	Transmit	Receive	Transmit	Receive	Transmit	Receive
20	24	310	160	299	151	321	157	321	163	321	157
40	12	310	160	310	154	287	166	200	166	182	166
60	8	264	163	224	163	192	163	134	134	122	122
80	6	199	160	169	160	145	145	101	101	92	92
100	5	160	160	137	137	117	117	81	81	74	74
120	4	133	133	113	113	97	97	67	67	61	61
128	3	123	123	100	100	87	87	62	62	56	56

* Full duplex facility or four-wire switched network

** Nonswitched half-duplex facility or two-wire switched

Figure 49. Communications Throughput Rates with Expanded Communications Features

IBM 3713 PRINTER

The IBM 3713 Printer (Figure 50) is available as a feature attachment on the 3741. It enables the 3741 to prepare hard copy from disk offline.

The 3713 has these characteristics:

- A maximum print rate of 40 characters per second.
- A maximum print line of 132 characters.

Note: Early shipments of the IBM 3713 Printer have a line length of 128 characters, not 132. If your 3713 does not have the 132 character line length, it can be field upgraded. Contact your IBM representative for more information.

- Three different pin feed platens, with pin-to-pin widths of 12-1/2 inches (317.5 mm), 13-1/8 inches (333.375 mm), or 13-7/8 inches (352.425 mm).
- A carriage return speed of 12 inches (304.8 mm) per second.
- A paper advance speed of 125 milliseconds per advance. Advance may be one or two lines, depending on the setting of the line-feed select lever.
- The carriage return function is overlapped with the vertical skip function.
- The print head traverses across the print line at 4 inches (101.6 mm) per second (40 CPS) independent of print content. (The rate is the same whether printing or not.)
- Forms with a maximum thickness of 0.018 inch (0.46 mm) (6-part forms) may be used, but for optimum feeding and stacking, IBM recommends using no more than three parts.
- Unattended print operations under the control of the expanded communications feature (*Chapter 10. Communications*).

The following features are available with the 3713 printer:

- Adjustable margins.
- Forms stand.

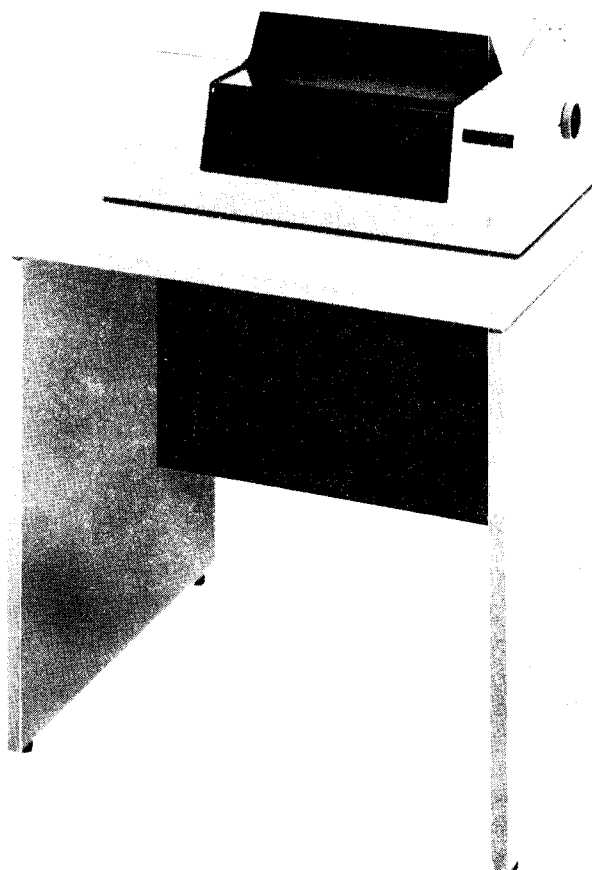

Figure 50. IBM 3713 Printer

IBM 3713 Adjustable Margins Feature

An adjustable margins feature permits the use of 11 additional platen widths ranging from 5-1/4 to 11-1/2 inches (133.35 to 292.1 mm) pin-to-pin. By manually repositioning margin stops and interchanging platens, a variety of printer forms can be used as required by your applications.

IBM 3713 Forms Stand Feature

This feature permits stacking of continuous forms on a stand above floor level.

IBM 3715 PRINTER

The IBM 3715 Printer is available as a feature attachment on the 3741. It enables the 3741 to prepare hard copy from disk. The 3715 is available in two models. The Model 1 prints at a maximum rate of 40 characters per second and the Model 2 prints at a maximum rate of 80 characters per second.

The 3715 has these characteristics:

- Bi-directional printing (left to right and then right to left). The 3715 bi-directional printing operates as follows.

The print head moves from the left margin. After the line is printed, the print head continues far enough to the right to enable the printing of the next line from right to left. The next line is then printed and the print head returns to the left margin again.

- Programmable editing capability.
- Automatic continuation of printing from disk 1 to disk 2 when a data set on disk 1 is continued on disk 2 (if the 3741 has the second disk feature).
- Allows unattended print operations under the control of the expanded communications feature (*Chapter 10, Communications*).
- A maximum print line of 132 characters.

Note: If 132 characters are formatted for forms less than 132 characters wide, loss of data will occur as the print head leaves the form.

- Capability of using individual or continuous forms. Maximum number of copies is six, but for optimum feeding and stacking IBM recommends a maximum of four parts per form.
- Adjustable forms tractor that allows the use of various width forms. The forms can be from 3 to 14.5 inches (76.2 to 368.3 mm) wide for individual forms and from 3 to 15 inches (76.2 to 381.0 mm) wide for continuous forms.
- A maximum print rate of 40 characters per second on the Model 1 and a maximum print rate of 80 characters per second on the Model 2.
- Print position spacing of 10 characters per inch (25.4 mm).
- Printing with or without format control.
- Use of both 3713 and 3717 printer programs.

- Spaces are inserted for characters not represented on the 3741 keyboard. If the 3741 PROG NUM SHIFT switch is in the ALL CHAR position, no error is indicated. If the switch is in the NUMBERS ONLY position, the printer stops and an error is indicated on the CRT display. The operator can press RESET or REC ADV to continue printing, or RESET twice to discontinue the printer mode.

- Printing of constant data stored in program buffers.
- Program chaining.
- Page numbering and page heading capability.
- Stapled forms or continuous card stock cannot be used.

The following formula shows how to determine nominal throughput for most 3715 Printer applications.

L = lines per minute

$$L = \frac{60}{(PT \times RL) + (LF \times NL) + 0.15}$$

PT = Character print time
0.025 for 3715 Model 1
0.0125 for 3715 Model 2

RL = Character length of print line

LF = Line feed time (0.030 seconds per line)

NL = Number of line feeds per print line

For example, nominal speed for a 3715 Model 2 printing 40-character print lines and double spacing is determined as follows:

$$L = \frac{60}{(0.0125 \times 40) + (0.030 \times 2) + 0.15} = 84.5 \text{ lines per minute}$$

In some applications, throughput may be reduced by:

- Multiple disk reads per print line
- Complex editing and reformatting
- Print line length of less than 10 characters.

IBM 3715 Forms Stand Feature

This feature permits stacking of continuous forms on a stand above floor level.

IBM 3717 PRINTER

The IBM 3717 Printer is available as a feature attachment on the 3741. It enables the 3741 to prepare hard copy from disk.

The 3717 has these characteristics:

- Two character sets that are interchangeable. The 64 character set consists of the characters represented on the keyboard. The 48 character set consists of the characters A through Z, 0 through 9, and . ' , + \$ * & - / % # @.
- A maximum print rate of up to 155 lines per minute with a 48 character set; up to 120 lines per minute with a 64 character set.
- A maximum print line of 132 characters.
- A line print time of 0.355 seconds for the 48 character set, 0.466 seconds for the 64 character set.
- A paper feed time of 0.036 seconds for the first line and 0.014 seconds for each additional line. This is a multiple line advance rate of 12 inches (304.8 mm) per second.
- Printing with or without format control.
- Engraved character font.
- Printing with editing capability.
- Automatic continuation of printing from disk 1 to disk 2 when a data set on disk 1 is continued on disk 2 (if the 3741 has the second disk feature).
- Six part forms with a maximum thickness of 0.020 inch (0.51 mm) can be used. Stapled forms or continuous card stock forms cannot be used.
- Unattended print operations under the control of the expanded communication feature (*Chapter 10, Communications*).
- Use of both 3713 and 3715 printer programs.
- Printing of constant data stored in program buffers.
- Program chaining.
- Page numbering and page heading capability.

The 3717 is a pin feed device for use with continuous forms. The form can be from 3-1/2 to 15 inches (88.9 to 381.0 mm) wide. The length of the form from fold to fold can be 3 to 14 inches (76.2 to 355.6 mm).

IBM 3717 Forms Stand Feature

This feature permits stacking of continuous forms on a stand above floor level. For proper operation of the 3717 printer, the 3717 forms stand or its equivalent must be used and grounded through the grounding clips on the 3717.

FUNCTIONS

Printer Modes

The 3713, 3715, and 3717 can print in four different modes (each with or without printer format control):

1. Print record mode — the current buffer data is printed. The keying sequence FUNCT SEL upper and PRINT REC causes the displayed record to be printed. The 3715 prints in one direction when under local format control. After the printing is complete, the 3741 returns to the mode of operation prior to the print record operation.
Note: Deleted records are printed in print record mode.
2. Print data set mode — the current data set is printed. The keying sequence FUNCT SEL upper and PRINT TO EOD initiates the printing of a data set. If printing is initiated from read index mode, the record at the BOE address, followed by all succeeding records up to the EOD address are printed. If the printing is initiated from update mode, the record displayed and all succeeding records up to the EOD address are printed. When the EOD address is encountered, printing stops and the 3741 returns to read index mode with the label for the data set displayed. Printing is not active in verify mode. If print data set is initiated in enter mode, no printing occurs and the 3741 returns to read index mode and displays the label of the data set.

The data set can be on more than one diskette (a continued data set). When a 3741 with a 3713 Printer or a single drive 3741 with a 3715 or 3717 Printer reaches the last record in a continued data set for the current diskette, a J (incomplete print) error occurs. The operator resets the error (the 3741 automatically returns to the index track), removes the diskette, inserts the next diskette in the sequence, selects the proper data set label, and then presses FUNCT SEL upper, NUM SHIFT, and PRINT TO EOD to continue the printing operation. This process continues until the last record of the multi-volume data set is printed.

On the 3715 or 3717, if the second disk feature is installed, printing can automatically continue from disk 1 to disk 2. However, the following conditions must exist in order for the printer to automatically continue:

- The data set on disk 1 must be a continued data set.
- The first valid data set label on disk 2 must identify the continued data set.
- The diskette must be inserted in drive 2 prior to the initiation of printing.

When the 3715 or 3717 completes printing the records from disk 1, and with the preceding conditions present, the printer automatically switches to disk 2 and continues printing the data set.

When the printing of the data set from disk 2 is complete, the incomplete print (J) error is displayed if the data set is continued on another diskette or diskettes. The operator can then perform the procedure to continue the print data set operation. (Drive 1 or drive 1 and drive 2 can be loaded with diskettes if appropriate.) This process continues until the last record of the multivolume data set is printed.

Note: Deleted records are not printed in print data set mode.

3. Print under search content mode — the records found within the current data set under search on content are printed.

The following keying sequence initiates the print under search content operation:

- FUNCT SEL lower
- SEARCH CONTENT
- Search mask
- FUNCT SEL upper
- PRINT TO EOD

The operation starts with the currently displayed record (or BOE record if printing operation is selected from read index mode) and prints all records that match the mask. When EOD is reached, the 3741 returns to read index mode and displays the label for the data set.

Notes:

1. Deleted records are not printed in print under search content mode.
2. The R format control character is operational in print under search content mode, except on 3713 printers with a maximum line length of 128 characters.

4. Print under search address mode — the record found under search on address is printed.

The following keying sequence initiates the print under search address operation:

- FUNCT SEL lower
- SEARCH RECORD ADDRESS
- Record address
- FUNCT SEL upper
- PRINT TO EOD

This printing operation prints the record at the specified address. When the operation is complete, the 3741 is in update mode with the record printed remaining displayed.

Notes:

1. Deleted records are not printed in print under search address mode.
2. The R format control character is operational in print under search address mode, except on 3713 printers with a maximum line length of 128 characters.

Printer Formatting

The format of output on the printer can be controlled in one of two ways:

1. Local format control—the location having the printer can write printer format programs and load these programs into the program level buffers of the 3741.
2. CPU format control—the transmitting station (usually a central computer) can send printer control characters intermixed with data. The printer control characters determine the format of the output.

The choice of format control method depends on the user's requirements. Local format control would probably be selected if:

- Control and flexibility of print formatting is desired at local site.
- Processing unit output reprogramming can be avoided.

Processing unit format control would probably be selected if:

- Maximum teleprocessing efficiency is important (accomplished by eliminating unprinted blanks, zeros, etc. and by packing data into large transmission blocks).
- Maximum data storage on disk(s) is desired.
- Central control of printer formatting is desired.

Local Format Control

Under local format control, printer format instructions reside in program buffers. The operator loads the printer format programs into the program buffers the same as key entry programs are loaded. See *Printer Instruction Set* for information on writing printer format programs. Up to nine printer format programs can be written and loaded at one time. The printer format programs can be loaded into program buffers 1 through 9.

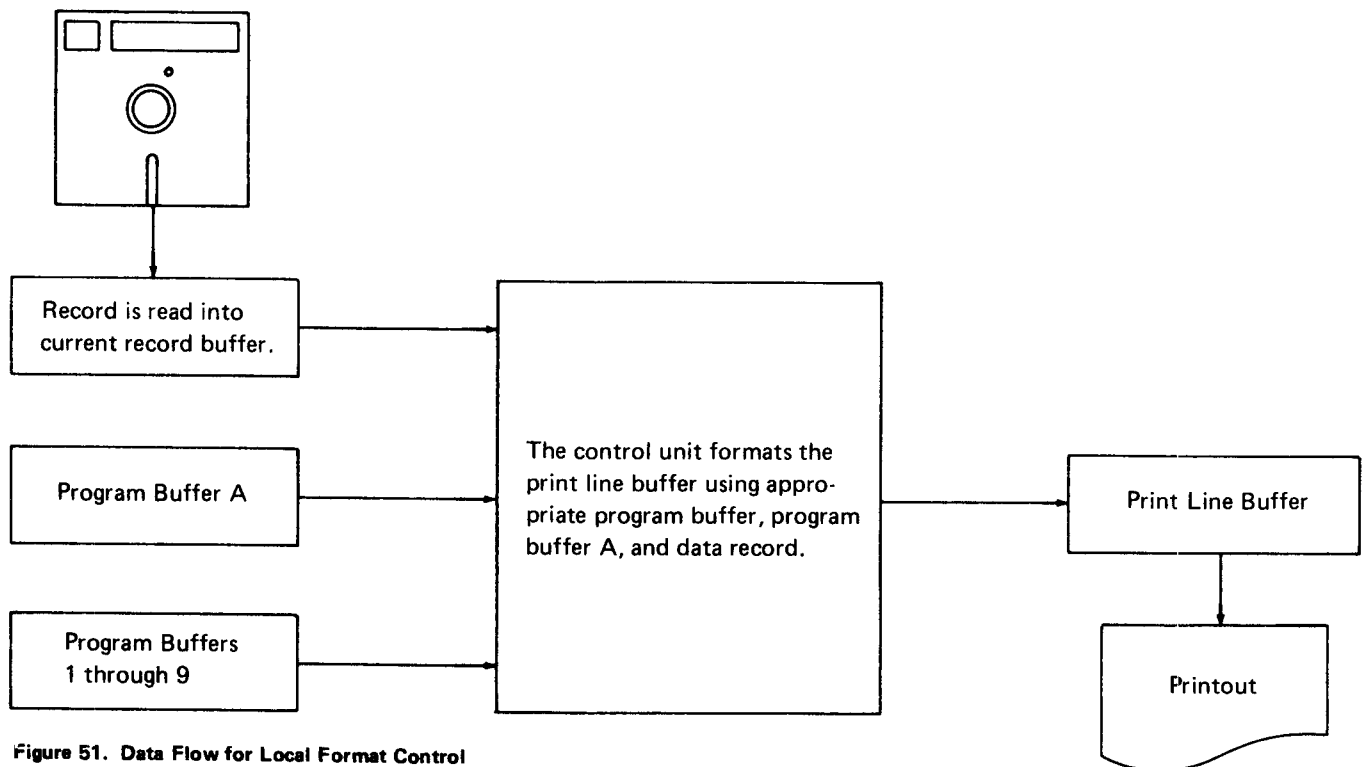

Figure 51. Data Flow for Local Format Control

Program buffer A contains the horizontal tab stop, vertical skip stop, and printer format program selection characters. See *Printer Format Program Select, Horizontal Tab/Vertical Skip Forms Control* for a complete description.

Figure 51 shows the data flow for local format control.

Printer Instruction Set

The printer instruction set is a group of printer format control characters that provide information for printing records. A printer format program consists of printer format control records and indicates the printing format for a record. Printer format programs can be loaded into program buffers 1 through 9. A printer format program can be selected automatically or manually by the operator. For information on printer format selection, see Figure 53.

Figure 52 lists each printer format control character and its meaning. The control characters are for the 3713, the 3715, and the 3717 unless otherwise indicated.

Control Character	Meaning	Control Character	Meaning
xA	Print data field: Loads the print buffer from the record with the number of characters specified by the number preceding the A format characters.	xT	Tab: Loads the print buffer with blanks up to but not including the tab stop position indicated in program buffer A. The number preceding the T control character determines the number of tabs that are to be executed. For example, if a 2 is in front of the T, the printer will execute a tab function from the current position to the position indicated by the second tab stop character encountered in program buffer A.
xB	Print data field with suppression of leading zeros: Loads the print buffer from the record with the number of characters specified by the number preceding the B format character, but loads blanks instead of leading zeros. Blanks in the input buffer are treated as significant digits, not as zeros, and therefore will stop zero suppression.	xC	Carriage return/line feed: Prints the contents of the print buffer and then performs the number of carriage return/line feeds as specified by the number preceding the C format character. This character must be used at the end of every print line.
xZ	Print data field with substitution of asterisks for leading zeros: Loads the print buffer from the record with the number of characters specified by the number preceding the Z format character, but loads asterisks (*) instead of leading zeros.	xS	Vertical skip: Vertically spaces until it reaches the skip stop in program buffer A that matches the number preceding the S format character in the current program. Continuous vertical spacing results if the skip stop is not found in program A. A 1S will also stop in position 001 of program A.
xD	Print signed data fields: Loads the print buffer from the record with the number of characters specified by the number preceding the D format character, and follows that field with a blank if the last character from the record does not have a D zone. If the last character from the record has a D zone, loads the last character with an F zone and follows the field with a minus sign.	R	Read next record: The R format character is used when more than one record is to be formatted with one program buffer. The remaining unformatted characters of the previous record are bypassed with no action. If the R character is used when a % sign is in program buffer A, the first character of the new record is compared with the current program number. If they are the same, format control continues with the current program. If they are different, format control is transferred to 001 of the program buffer indicated by the first character of the new record.
XX	Prints blanks: Loads the print buffer with the number of blanks specified by the number preceding the X format character.	Q	Terminates printer program: This printer format control character must be used at the end of every printer program. It reads the next record, terminates the formatting and returns the format control to position 001 of the current program level.
XY	Skips characters from the record: Skips over, with no action, the number of characters in the record specified by the number preceding the Y format character.		
XF	Reverse skip characters from the record: Skips over, in reverse direction (towards position 1) with no action, the number of characters in the record specified by the number preceding the F format character. (<i>Note:</i> It is not permissible to skip beyond record boundaries.)		

Note: The x represents a variable value that is the multiple of the control character to be executed. If a control character is preceded by a blank, 0, or another control character, the multiple is assumed to be 1.

Figure 52 (Part 1 of 2). Printer Format Control Characters

Control Character	Meaning	Control Character	Meaning
N	No-op: This character must be used in the first position of a manually selected printer format. It prevents an error condition from occurring when this printer format is manually selected.	xL	Program link (3715 and 3717 only): Indicates that the printer program control is to be transferred to the start of the program specified by the number preceding the L control character.
W	Load disk address (3715 and 3717 only): Causes the disk address to be loaded into the print buffer. The disk address is a four digit number in the form TTSS where TT is the track number and SS is the sector number.	P	Load page number (3715 and 3717 only): Causes the page number to be loaded into the print buffer. The page number is a three digit number with leading zeros when required. The numbering is 001, 002, ..., 254, 255, 000, 001,...
xI	Insert characters (3715 and 3717 only): Loads the print buffer from the current program buffer with the characters following the I. The number preceding the I indicates the number of characters to be loaded into the print buffer.	(apostrophe)	Edit word begin-end (3715 and 3717 - only): Defines the beginning and the end of an edit word.
xHmL	Conditional skip (3715 and 3717 only): This control character is the same as the S control character except if the skip is over a page boundary, then the printer program control is transferred to the start of program m (m can be 1 through 9).		

Figure 52 (Part 2 of 2). Printer Format Control Characters

Printer Format Program Select, Horizontal Tab/Vertical Skip Forms Control

Under local format control, program buffer A can contain:

- Printer format program select characters.
- Printer horizontal tab stop characters.
- Printer vertical skip stop forms control characters.

Printer Format Program Select Character indicates whether the printer format instructions are obtained:

- From the program buffer selected manually by the operator.
- From the program buffer selected automatically from the content of position one of each data record.
- From the control characters in the data stream.

The printer format program select character must be in position 001 of program buffer A. Figure 53 shows the valid printer format program select characters and what each character represents.

Horizontal Tab and Vertical Skip Stop Characters

These characters can occupy positions 2 through 128 in program buffer A. Thus it is possible to format printer forms up to 128 print lines long and tab up to print position 128. (Tab stops are not allowed in positions 129-132.) The horizontal tab stop character is used to specify tab stop positions and the vertical skip stop character is used to specify the skip to positions.

Printer Format Program Select Character	Meaning
: (colon)	The colon (:) means the printer format program is to be selected by the operator. You must indicate to the operator which program buffer is to be selected. <i>Note:</i> A colon (:) in position 001 of program buffer A with program buffer 0 selected means that records are printed one record per line with no format control (this means that each data record is printed as it exists on the disk).
% (percent)	The percent (%) sign means the printer format program buffer is selected, record by record, by the content of position 001 of each record. A three in position 001 of a record selects program buffer three for that record. <i>Note:</i> If position 001 of the data record contains a 0 or a non-numeric character, each record is printed with no format control (this means each data record is printed as it exists on disk).
+ (plus)	The plus (+) sign means the format of the print line is controlled by print control characters in the data stream. See <i>Processing Unit Format Control</i> in this chapter.
All other characters	Any other character used in position 001 of program buffer A causes records to be printed one record per line with no format control for the record.

Figure 53. Printer Format Program Selection Characters

Function Desired in Current Printer Format Program	Vertical Skip Stop Character	
	With no tab function, use:	With tab function included, use:
Skip to 1	1	J
Skip to 2	2	K
Skip to 3	3	L
Skip to 4	4	M
Skip to 5	5	N
Skip to 6	6	O
Skip to 7	7	P
Skip to 8	8	Q
Skip to 9	9	R
End of Form*	E	F

*The character (E or F) is placed in program buffer A at one position greater than the number of available print lines per form. For example, if there are 60 print lines per form, the character (E or F) would be placed in position 61 of program buffer A.

Figure 54. Vertical Skip Stop Characters

Tab stops are indicated by placing a T in the desired positions in program buffer A. When a T is encountered in the currently selected printer format buffer, horizontal tabbing is initiated.

Vertical skip stop positions are indicated by placing skip stop characters in the desired positions in program buffer A. Vertical skipping is initiated when an S is encountered in the currently selected printer format buffer. Each position in program buffer A represents one line on the printer form. When the printer prints a line and a carriage return occurs, a counter increments to the next position in program buffer A. Therefore, the number of lines that are skipped when a skip is initiated is the number of positions from the current position to the indicated vertical skip stop character.

When both a horizontal tab stop and vertical skip stop character are required in the same position in program buffer A, a second set of skip stop characters is used. Figure 54 shows the vertical skip stop characters that can be used to combine vertical skip and horizontal tab stop characters.

The following is an example of vertical skipping. Assume that a 2S has been encountered in the current printer format program and the printer is currently on line 5 of the form. Figure 55 shows how the skipping would occur.

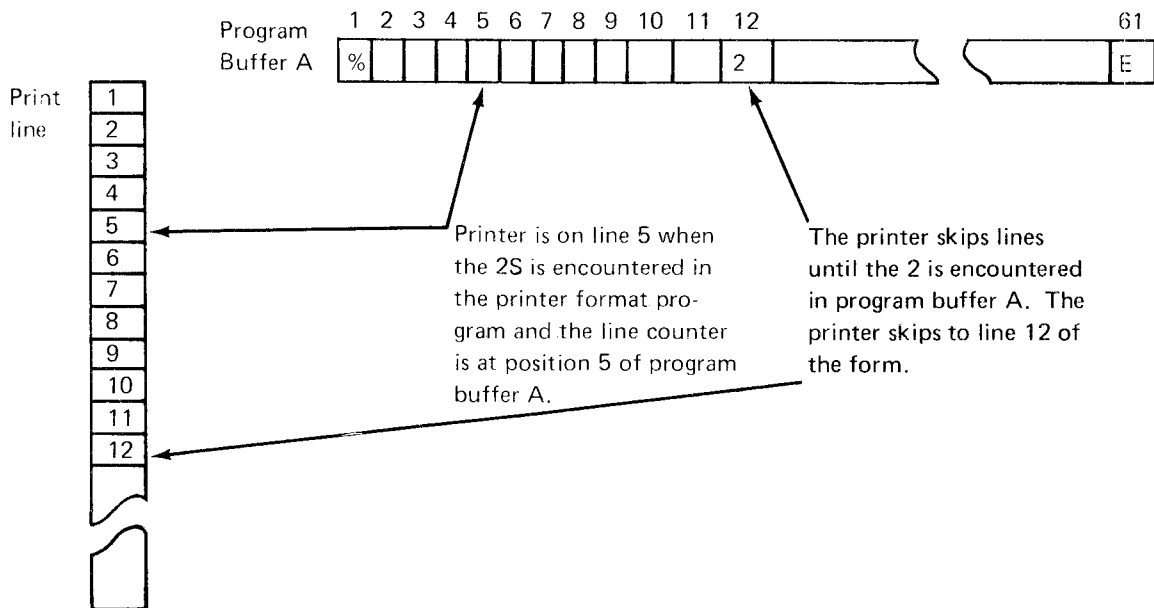
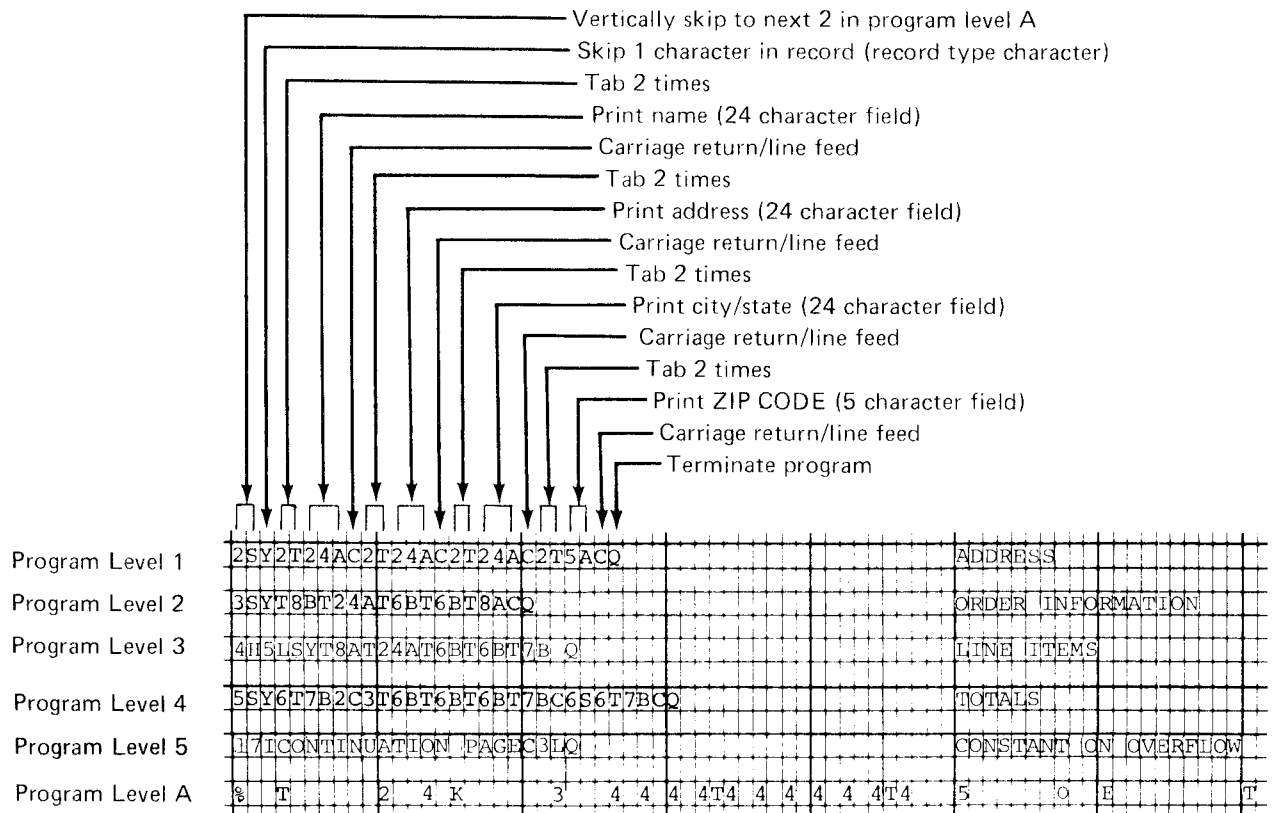

Figure 55. Vertical Skipping Example

	Name	Address	City/State	Zip Code
Sold to	ABC ELECTRIC CO	1234 SNELLING AVE	MINNEAPOLIS MINN.	55401
Ship to	XYZ ELECTRIC INC	6553 WEST LAKE	MINNETONKA MINN.	55403
Miscellaneous	292354 PARCEL POST	20961404028006/07/72		
Detail 1	3245-2890 INSULATOR	00002000.730001.4600092354		
Detail 2	3917-0214 RELAY	00001012.300012.3000092354		
Detail 3	3258-1478 BATTERY	00006001.010006.0600092354		
Detail 4	3369-2587 CHOKE	00010002.470024.7000092354		
Detail 5	3987-6543 HEAT SINK	00003012.050036.1500092354		
Detail 6	3654-3210 GENERATOR	00002003.620007.2400092354		
Totals	40087.910701.40107.87010.700188.970276.88			
Character Position	1 11 21 31 41 51 61 71 81			



Figure 57. Sample Records on Disk



Note: If an automatically selected printer format program is to be displayed or changed, an N (No-op) must be in position one of the program level. If it is omitted, an error condition occurs when the format program is selected to be displayed.

● Figure 58. Sample Printer Format Programs

Program Level
(see Figure 58)

	 ELBARISA 	WEST FRONT STREET WORLD WIDE																	
1 1 1 1*	SOLD TO: ABC ELECTRIC CO 1234 SNELLING AVE MINNEAPOLIS MINN. 55401	Worldwide Distribution of Electronic Parts and Instruments																	
1 1 1 1	SHIP TO: XYZ ELECTRIC INC 6553 WEST LAKE MINNETONKA MINN. 55403	TERMS 2% - 10 DAYS NET 30 DAYS																	
2	<table border="1" style="width: 100%; border-collapse: collapse;"> <thead> <tr> <th style="width: 20%;">CUSTOMER NO</th> <th style="width: 20%;">SHIPPED VIA</th> <th style="width: 20%;">CUST. ORDER NO</th> <th style="width: 20%;">INVOICE NUMBER</th> <th style="width: 20%;">INVOICE DATE</th> </tr> </thead> <tbody> <tr> <td>92354</td> <td>PARCEL POST</td> <td>219614</td> <td>40280</td> <td>06/07/72</td> </tr> <tr> <th>PART NUMBER</th> <th>DESCRIPTION</th> <th>QUANTITY</th> <th>UNIT PRICE</th> <th>AMOUNT</th> </tr> </tbody> </table>	CUSTOMER NO	SHIPPED VIA	CUST. ORDER NO	INVOICE NUMBER	INVOICE DATE	92354	PARCEL POST	219614	40280	06/07/72	PART NUMBER	DESCRIPTION	QUANTITY	UNIT PRICE	AMOUNT			
CUSTOMER NO	SHIPPED VIA	CUST. ORDER NO	INVOICE NUMBER	INVOICE DATE															
92354	PARCEL POST	219614	40280	06/07/72															
PART NUMBER	DESCRIPTION	QUANTITY	UNIT PRICE	AMOUNT															
3	245-2890	INSULATOR	2	.73	1.46														
3	917-0214	RELAY	1	12.30	12.30														
3	258-1478	BATTERY	6	1.01	6.06														
3	369-2587	CHOKE	10	2.47	24.70														
3	987-6543	HEAT SINK	3	12.05	36.15														
3	654-3210	GENERATOR	2	3.62	7.24														
4	TOTAL THIS INVOICE \Downarrow				87.91														
4	PREVIOUS BALANCES	70.40 +	107.87 +	10.70 =	188.97														
		60 DAYS & OVER	30 DAYS	CURRENT															
4	TOTAL BALANCE DUE				276.88														

*Use Program Level 5 if the page overflows.

● Figure 59. Sample of Desired Formatted Output

Processing Unit Format Control

Under processing unit format control, the format control characters are in the data stream instead of residing in program buffers. With processing unit format control, the operator loads program buffer A prior to initiating printing. As was shown in Figure 53, a plus (+) in position 001 of program buffer A instructs the printer to accept control characters imbedded in the data stream. Characters in positions 2 through 128 in program buffer A provide the same function as in local format control. (See *Printer Format Program Select, Horizontal Tab/Vertical Skip Forms Control*, for a complete description.) Figure 60 shows the data flow for processing unit format control.

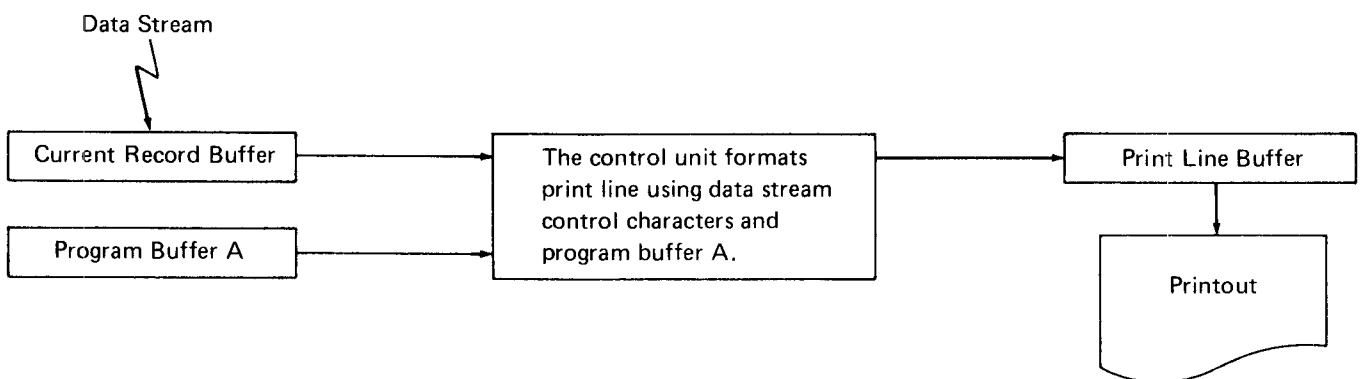

Figure 60. Data Flow for Processing Unit Format Control

Note: For the 3715 and 3717, if the print data set function is selected from update mode, the position of the cursor determines the first character to be printed.

In the 3715, program buffer 9 is used and previous information in program buffer 9 is displaced when printing.

Printer Instruction Set: Figure 61 shows the printer format control characters that can be recognized in the data stream. Figure 62 shows an example of four data records residing on the 3741 disk. These records include the necessary data stream printer control characters such that after loading program buffer A (Figure 63) the resultant printer output is identical to that previously shown in Figure 59.

Control Function	Control Characters*	Meaning
Tab (HT)	'05'	Tab to next tab stop in program buffer A.
Null (NUL)***	'00'	Hex character is ignored. (Removed from data stream with no blank printed.)
New line (NL) or line feed (LF)	'15' '25'	a. Execute a carriage return/line feed function if there is no pending ESC function. b. Execute carriage return and ESC function if there is a pending ESC function.

Figure 61 (Part 1 of 2). Data Stream Printer Control Characters

Control Function	Control Characters*			Meaning
Blank expansion (IGS) (n) ***	<i>No. of blanks</i>	<i>(IGS)</i>	<i>(n)</i>	Blank expansion allows strings of n consecutive blanks in the data stream to be replaced by a two character sequence (n can be up to 63). This two character sequence must be consecutive. If more than 63 blanks are required, two sequences are strung together. For example, for 70 blanks: G6G7 S3S
	2	'1D'	'42'	
	3	'1D'	'43'	
	4	'1D'	'44'	
	.	.	.	
	15	'1D'	'4F'	
	.	.	.	
	31	'1D'	'5F'	
	.	.	.	
	47	'1D'	'6F'	
.	.	.		
63	'1D'	'7F'		
Escape (ESC) A	'27'A			Skip to the next code 1 in program A**
Escape (ESC) B	'27'B			Skip to the next code 2 in program A
Escape (ESC) C	'27'C			Skip to the next code 3 in program A
Escape (ESC) D	'27'D			Skip to the next code 4 in program A
Escape (ESC) E	'27'E			Skip to the next code 5 in program A
Escape (ESC) F	'27'F			Skip to the next code 6 in program A
Escape (ESC) G	'27'G			Skip to the next code 7 in program A
Escape (ESC) H	'27'H			Skip to the next code 8 in program A
Escape (ESC) I	'27'I			Skip to the next code 9 in program A
Escape (ESC) /***	'27'/'			Skip one line
Escape (ESC) S***	'27'S			Skip two lines
Escape (ESC) T***	'27'T			Skip three lines
Escape (ESC) U***	'27'U			Skip four lines
Escape (ESC) V***	'27'V			Skip five lines
Escape (ESC) W***	'27'W			Skip six lines
Escape (ESC) X***	'27'X			Skip seven lines
Escape (ESC) Y***	'27'Y			Skip eight lines
Escape (ESC) Z***	'27'Z			Skip nine lines
<p>Note 1: The last ESC function is executed by the NL, LF, or the next ESC control character.</p> <p>Note 2: If the print buffer is filled with 132 characters and the next character is not an NL, LF, or ESC sequence, a printer format error occurs.</p> <p>*Numbers in the column are hexadecimal notation.</p> <p>**An (ESC) A will also stop in position 001 of program buffer A.</p> <p>***Early shipments of the IBM 3713 Printer do not have support for Blank expansion (IGS) (n) and the Escape control characters: /, S, T, U, V, W, X, Y, Z, or blank expansion. If your 3713 does not support these control character functions, it can be field upgraded. Contact your IBM representative for more information.</p>				

Figure 61 (Part 2 of 2). Data Stream Printer Control Characters

EDITING ON THE 3715 AND 3717

The 3715 and 3717 provide comprehensive editing capability. Editing is a means of punctuating numeric fields by suppressing zeros and inserting decimal points, commas, signs of fields (positive or negative), dollar signs, or other constant information. Editing is accomplished by loading edit words into program buffers.

An edit word consists of edit characters that indicate the desired editing function to be performed. Figure 64 shows the edit characters and their meaning. Edit words are placed in the printer format program along with the printer format control characters and must be enclosed by apostrophes (').

Figure 65 shows examples of zero suppression using edit words, Figure 66 shows examples of floating characters using edit words, and Figure 67 shows examples of character insertion using edit words.

Editing Consideration

One important thing to keep in mind is that enough space must be allowed on the printed form for the edited fields. If the input field to be edited is seven characters long, consider whether seven positions allows enough space for it to be printed on the report. By the time the field is edited, it may contain more than seven characters.

Edit Character	Meaning
9	Decimal digit. A decimal digit is accepted for output in the corresponding position of the print buffer.
Z	Suppress leading zeros. The corresponding position in the print buffer is blanked if the character is a leading zero.
B	Insert blank character. A blank is inserted into the corresponding position in the print buffer.
Y	Insert blank character if zero. A blank is inserted into the corresponding position in the print buffer if the position contains a zero.
*	Insert asterisk. An asterisk is inserted into the corresponding position in the print buffer if the position contains a leading zero.
,	Insert comma. A comma is inserted into the corresponding position in the print buffer. A comma is <i>not</i> inserted into the indicated position if zero suppression has occurred.
/	Insert slash. A slash is inserted into the corresponding position in the print buffer. A slash is <i>not</i> inserted into the indicated position if zero suppression has occurred.
.	Insert period. A period is inserted into the corresponding position in the print buffer. A period is <i>not</i> inserted into the indicated position if zero suppression has occurred.

Figure 64 (Part 1 of 2). Edit Characters

Edit Character	Meaning
V	Stop zero suppression. The V stops zero suppression at the corresponding position in the print buffer. The V must be followed by a comma, slash, or period.
\$	Insert dollar sign. The dollar sign can be at a fixed position or floating (placed to the left of the most significant digit). To insert the dollar sign at a fixed position, place only one dollar sign character at the desired position. To insert a dollar sign to the left of the most significant digit, place a dollar sign character in all leading digit positions of the associated field.
-	Insert minus sign. A minus sign can be placed at a fixed position or floating (placed to the left of the most significant digit) if the field is negative. To insert the minus sign at a fixed position, place one minus sign at the desired position. To insert a minus sign to the left of the most significant digit, place a minus sign character in all leading digit positions of the associated field.
+	Insert plus sign. A plus sign can be placed at a fixed position or floating (placed to the left of the most significant digit) if the field is positive. To insert the plus sign at a fixed position, place one plus sign at the desired position. To insert a plus sign to the left of the most significant digit, place a plus sign character in all leading digit positions of the associated field.
S	Insert sign. This edit character is used to insert the sign (+ or -) of a field. The sign can be placed at a fixed position or floating (placed to the left of the most significant digit). To insert the sign of the field at a fixed position, place one S at the desired position. To insert the sign to the left of the most significant digit, place an S in all leading digit positions of the associated field.
CR	Insert CR. CR is inserted in the associated positions in the print buffer if the field is negative; otherwise, the associated positions are blank.
DB	Insert DB. DB is inserted in the associated positions in the print buffer if the field is positive; otherwise, the associated positions are blank.
"	Insert edit word constant. The characters enclosed by quotes (") are inserted in the associated positions in the print buffer. The quotes are not printed.

Figure 64 (Part 2 of 2). Edit Characters

Input Field	Edit Word	Output Field
12345	ZZZ99	12345
00100	ZZZ99	bb100
00000	ZZZ99	bbb00
00100	ZZZZZ	bbi00
00000	ZZZZZ	bbbbbb
00100	*****	**100
00000	*****	*****
00100	YYYYY	bb1bb
10203	9Y9Y9	1b2b3

Figure 65. Examples of Zero Suppression

Input Field	Edit Word	Output Field
1234	9,999	1,234
123456	9,999.99	1,234.56
1234	ZZ.ZZ	12.34
1234	ZZV.99	12.34
0003	ZZ.ZZ	bbb3
0003	ZZV.99	bb.03
0000	ZZ.ZZ	bbbbbb
0000	ZZV.99	bb.00
123456789	9,999,999.99	1,234,567.89
1234567	**,999.99	12,345.67
0012345	**,999.99	***123.45
123456789	9.999.999,99	1.234.567,89
123456	99/99/99	12/34/56
123456	99.9/99.9	12.3/45.6
001234	ZZ/ZZ/ZZ	bbb12/34
000012	ZZ/ZZ/ZZ	bbbbbb12
000000	ZZ/ZZ/ZZ	bbbbbbbbbb
000000	**/**/**	*****
123456	99B99B99	12b34b56
123	9BB9BB9	1bb2bb3
12	9BB/9BB	1bb/2bb

Figure 67. Examples of Character Insertion

Input Field	Edit Word	Output Field
12345	\$999.99	\$123.45
00123	\$ZZZ.99	\$bb1.23
00000	\$ZZZ.ZZ	\$bbbbbb
12345	\$\$9.99	\$123.45
00123	\$\$9.99	bb\$1.23
12	99\$	12\$
00012	\$\$\$999	bbb\$012
01234	\$\$\$999	b\$1,234
12345	S999.99	+123.45
1234N	S999.99	-123.45
1234N	+999.99	b123.45
12345	-999.99	b123.45
12345	999.99S	123.45+
00123	++B+9.99	bbb+1.23
00123	--9.99	bbb1.23
0012L	SS9.99	bb-1.23

Figure 66. Examples of Floating Characters

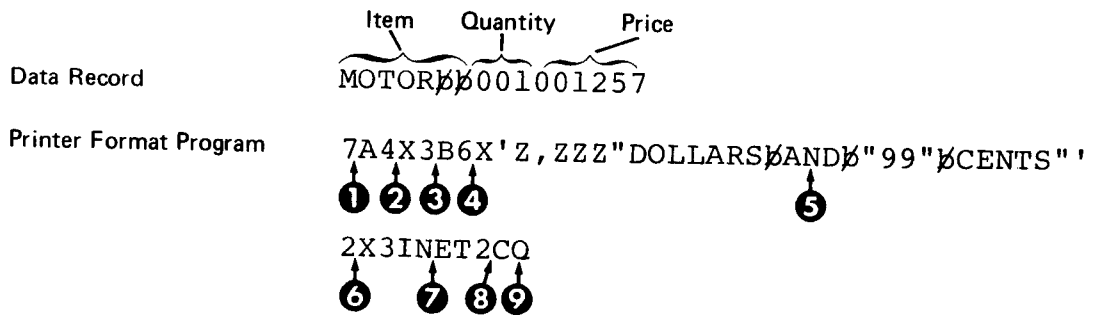

- ① 7A – means load the print buffer with seven characters from the record.
- ② 4X – means load print buffer with four blanks.
- ③ 3B – means load print buffer with three characters from the record and suppress leading zeros (001).
- ④ 6X – means load print buffer with six blanks.
- ⑤ 'Z,ZZZ"DOLLARS"AND"99"CENTS'' – Edit word to punctuate price field and insert constants.
- ⑥ 2X – means load print buffer with two blanks.
- ⑦ 3INET – The 3I means load the print buffer with three constant characters NET.
- ⑧ 2C – means perform carriage return and two line feeds.
- ⑨ Q – means end of printer program.

Print Line MOTOR 001001257 DOLLARS AND 57 CENTS NET

Chapter 12. Proof Keyboard Feature

The 3741 proof keyboard differs from a standard 3741 keyboard only by a rearrangement of the numeric keys. The proof keyboard numeric key arrangement allows the operator who is more familiar with the adding machine numeric key arrangement to more effectively enter data.

Figure 68 shows the numeric keys on a proof keyboard and the numeric keys on a standard keyboard. In alpha shift, both the standard keyboard and the proof keyboard operate the same.

Note: A 3741 can have either the proof keyboard numeric key arrangement or the standard keyboard numeric key arrangement, but both numeric key arrangements are not available on the same 3741.

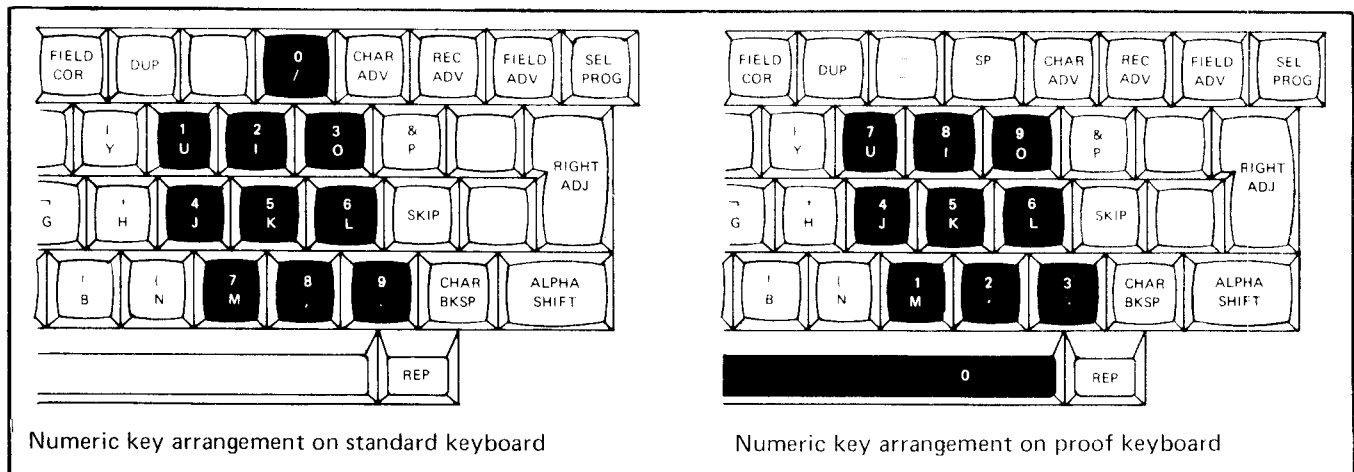

Figure 68. Proof Keyboard and Standard Keyboard Numeric Key Arrangements

Chapter 13. Data Recorder Attachment Feature

The Data Recorder Attachment feature attaches the IBM 129 Card Data Recorder Model 2 or the IBM 5496 Data Recorder Model 1 to a 3741. This feature allows a 3741 to read, punch, or punch/print via 129 (80 column cards) or a 5496 (96 column cards) data recorder. When not on-line with a 3741, the data recorders operate with their standalone functions.

The data recorders have these online characteristics:

- Capability to read, punch, or punch/print cards.
- A locked keyboard from which data cannot be entered.
- The 129 Model 2 reads individual cards as a rate of up to 50 cards per minute and punches cards at a rate of 11 to 39 cards per minute.
- The 5496 Model 1 reads cards at a rate of 21 cards per minute and punches cards at a rate of 17 cards per minute.
- The 5496 Model 1 punches blanks for any character not represented on the 5496 keyboard.

PUNCH OPERATIONS

Punch Modes

The data recorders can punch in four different modes (each with or without format control). If the print switch on the data recorder is ON, the cards are punched and printed.

Notes:

1. If the AUTO REC ADV switch (on the 3741) is in the OFF position in the punch data set, punch under search content, and punch under search address modes, the number of cards specified by the card read/punch program are punched each time REC ADV is pressed. If the AUTO REC ADV switch is in the ON position, the punch operation is continuous.
2. To cancel punch operations, press ALPHA SHIFT, NUM SHIFT, and RESET simultaneously.

Punch Record Mode

The keying sequence, FUNCT SEL lower and N, places the 3741 in punch record mode. In this mode, the data (up to a maximum of 80 or 96 characters) in the current record buffer is punched each time FIELD COR is pressed.

The punch record function has the following mode characteristics:

- Read index, enter, update mode - When the punch record function is selected, the mode the 3741 is in remains active. For example, an operator places the 3741 in punch record mode from enter mode. Once the 3741 is placed in punch record mode, the operator can continue entering data. However, every time the operator presses FIELD COR, the data in the current record buffer is punched.
- Verify mode - The punch record function cannot be used during verify mode. The FIELD COR key (which is used to correct errors found during verification) will not cause the data in the current record buffer to be punched.
- To cancel the punch record mode, press FUNCT SEL lower and S.

Punch Data Set Mode

The keying sequence FUNCT SEL upper and PUNCH TO EOD places the 3741 in punch data set mode. In this mode, each record (up to a maximum of 80 or 96 characters) in the current data set is punched. When EOD is reached, the 3741 returns to read index mode and displays the data set label.

Note: The punch data set operation is limited to disk drive 1.

Punch Under Search Content Mode

The following keying sequence places the 3741 in the punch under search content mode:

- FUNCT SEL lower
- SEARCH CONTENT
- Enter the search mask either by keying it or reading it from a card.
- FUNCT SEL upper
- PUNCH TO EOD

In this mode, each record (up to a maximum of 80 or 96 characters) found within the data set under search on content is punched.

When EOD is reached, the 3741 returns to read index mode and displays the data set label.

Note: The punch under search content operation is limited to disk drive 1.

Punch Under Search Address Mode

The following keying sequence places the 3741 in the punch under search address mode:

- FUNCT SEL lower
- SEARCH ADDRESS
- Key in the record address
- FUNCT SEL upper
- PUNCH TO EOD

In this mode, each record (up to a maximum of 80 or 96 characters) found is punched. The punch under search address mode has the following characteristics:

- If initiated from the index track, all the records from the first record in the data set (up to and including the record at the record address specified) are punched.
- If initiated from a record address in a data set, all the records from that address (up to and including the record at the record address specified) are punched.

When the last record is reached, the 3741 returns to read index mode and displays the data set label.

Note: The punch under search address operation is limited to disk drive 1.

READ OPERATIONS

Read Modes

The data recorders can read in two modes (with or without format control).

Note: To cancel read operations, press ALPHA SHIFT, NUM SHIFT, and RESET simultaneously.

Read a Card Mode

The keying sequence FUNCT SEL lower and V places the 3741 in read a card mode. In this mode, a single card (record) is read at the data recorder each time FIELD COR is pressed. The card is read into the 3741 current record buffer. If the data is to be written to disk, REC ADV must be pressed.

The read a card function has the following mode characteristics:

- Read index, enter, update mode -- When the read a card function is selected, the mode the 3741 is in remains active. For example, an operator places the 3741 in read a card mode from enter mode. Once the 3741 is placed in read a card mode, the operator can continue entering data. However, every time the operator presses FIELD COR, a card is read into the current record buffer. The operator can then write the data in the current record buffer to disk by pressing REC ADV.
- Verify mode -- The read a card function cannot be used during verify mode. The FIELD COR key (which is used to correct errors found during verification) will not cause a card to be read.
- To cancel the read a card mode, press FUNCT SEL lower and S.

Continuous Card Read Mode

The keying sequence FUNCT SEL upper and READ TO EOF places the 3741 in continuous card read mode. In this mode, the data recorder reads cards until a card with ?* (indicates end-of-job) in columns 1 and 2 is read.

After a card (record) is read, it is written to disk. The location for writing to disk is specified by the operator either by positioning the disk on the data set label or on a record location within the data set. If the disk is positioned on a data set label, the first card read is written at the BOE (beginning-of-extent) of the data set label being displayed. If the disk is positioned on a record location, the first card read is written at the current disk address. The cards are written to disk with a record length equal to that specified in the data set label. When an end-of-job card is encountered, the EOD (end-of-data) is set equal to the current disk address plus one and an L is placed in position 45 of the data set label. The ?* (end of job) card is not written to disk.

If a disk is positioned on a data set label when the continuous card read operation is initiated, the data set label is checked to ensure that it is a valid HDR1 label and that it is not protected, bypassed, or deleted. Error B or G will occur if these conditions are not met. If a disk is in ENTER or UPDATE mode when the continuous card read operation is initiated, the data set label is checked after the operation is performed. If the label is bypassed, a B error occurs and the EOD in the label is not updated.

Notes:

1. In the CONTINUOUS CARD READ mode, if the AUTO REC ADV switch (on the 3741) is in the OFF position, the number of cards specified by the card read/punch program are read each time REC ADV is pressed. If the AUTO REC ADV switch is in the ON position, the read operation is continuous.
2. The continuous card read operation is limited to disk drive 1.

Multiple data sets can be created during the continuous read operation. To do this, the card files must be separated by a card that indicates end of file (?/ punched in columns 1 and 2 of the card). The following operations occur when an end of file card is read:

1. The data set label is updated as follows:
 - EOD is set equal to the next record address
 - An L is placed in position 45

Note: If EOE is encountered before an end-of-file card is read, an A6 error occurs. Three options are available when an A6 error occurs:

Option 1. If you want to continue reading cards on onto another disk, press both ALPHA SHIFT and NUM SHIFT with RESET, then change position 45 of the data set label to a C. Remove the diskette and insert a new one, then reselect the format program, if necessary, and press FUNCT SEL upper and READ TO EOF.

Option 2. If you want to change EOE address and continue reading cards onto the same data set, press both ALPHA SHIFT and NUM SHIFT with RESET, then modify the EOE address (be sure that data set label extents do not overlap). Search to EOD, press REC ADV, and reselect the format program, if necessary; then press FUNCT SEL upper and READ TO EOF.

Option 3. If you want to continue the card read operation on the same disk at the next valid data set location, press RESET (on the 3741) to continue.

Note: Do not use option 3 if you intend to use the data being read onto disk in any communication operations.

2. The index track is searched for the next valid data set label. The labels are checked as follows:
 - Valid HDR1
 - Not deleted
 - Not protected
 - Not bypassed

If any of the previous checks fail, the label is bypassed and the next label is checked. Otherwise, the following checks are performed:

- BOE is in the range of 01001 to 73026
- EOE is in the range of BOE to 73026
- Record length is in the range of 1 to 128

If any of these checks fail, a B error occurs. Also, an error A9 occurs if a valid data set label cannot be found. (When these errors are reset, the continuous card read operation is canceled.)

3. The continuous card read operation resumes at the BOE of the new data set. (If EOE was encountered, before an end-of-file card is read, the record length of the new data set is set equal to the record length of the original data set. If an end-of-file card was encountered, the record length of the new data set is used. The ?/ [end of file] card is not written to disk.)

FORMAT CURRENT RECORD BUFFER

Formatting of the current record buffer is done by pressing FUNCT SEL lower and X. The data in the current record buffer is transferred to program level 9 and formatted (under control of the format specified) back to the current record buffer. See *Card Read/Punch Format Control* for information on formatting records.

CARD READ/PUNCH FORMAT CONTROL

The 3741 uses program levels 1 through 8 for format control. Program level 0 means no format control. Program level 9 is used as the input/output buffer for the data recorder attachment feature and for formatting the current record buffer. (See *How Format Control Works* for more information on the input and output buffers.) Program level A is used for format program selection.

Program Level A

Program level A is used to define the type of format control. Format control can be either manually selected by the operator or automatically selected by a character in the input data.

Manual Selection

When manually selecting card read/punch format control programs, the operator selects a program level used for keying data, and program level A specifies the program level used for card read or punch operations. This is done by creating program level A as follows:

Position	1	2	3	4	5	6	7	8	9
Program level A	:	X	X	X	X	X	X	X	X

↑ (colon) ← selected key entry program
(1 2 3 4 5 6 7 8)

X represents the value 1 through 8 that specifies the program level used for card read/punch format control when the corresponding key entry program is selected. To illustrate how manual selection works, assume that:

- Program level A contains a colon (:) in position 1 and a 6 in position 4 (corresponding key entry program level is 3).
- Program level 3 is a key entry program and program level 6 is a card read/punch format control program.
- The operator places the 3741 in punch-a-record mode, selects program level 3, and enters data.

After the data is entered in the current record buffer, the operator presses FIELD COR. Program level 6 becomes active and the data in the current record buffer is punched.

Note: After the read-a-card or punch-a-record operation is complete, the selected key entry program is again active. After all other card read or punch operations are complete, the program level goes to 0.

If program level A is coded as follows:

1	2	3	4	5	6	7	8	9	← Position
:	2			1					← Program level A

↑ (colon) ← Corresponding key entry program
(1 2 3 4 5 6 7 8)

the following conditions exist:

- When program level 5 is manually selected, program level 1 is used for card read/punch operations.
- When program level 2 is manually selected, program level 2 is used for card read/punch operation; however, some precautions must be taken. If you are in enter mode and REC ADV is pressed to write the record to disk or if you key in data while program level 2 is still in control, the results are unpredictable. The 3741 will use the data recorder program as a key entry program which is invalid.
- If program level 1 is manually selected (even though program level 1 is a card read/punch format control program), no card read or punch formatting occurs. There must be a value coded in the appropriate position of program level A.

Automatic Selection

Program level A is created as follows when the format control program is automatically selected from a number (1 through 8) in the input data:

Position	1	2	3	4	5
Program level A	%	X	X	X	

↑ (percent)

XXX represents a number from 1 to 128 that defines the position in the input data of the program selection character. This number may be a 1, 2, or 3 digit number (for example, 1 or 001), and must always be followed by a blank. There cannot be a blank between the % and the XXX value. If this number is not coded, the default value is 1.

Note: If the 3741 is programmed so that it is waiting for the operator to key and yet is still under format control of a card read or punch program, the operator must select a key entry program before keying data. Failure to do this could result in loss of data.

Card Read/Punch Format Control Programs

Card read/punch format control programs are loaded into the program levels (1 through 8) the same as key entry programs. These programs consist of format control characters (see *Card Read/Punch Format Instruction Set*) and define the format for a record. Card read/punch format control programs are identified with a N& (ampersand) in positions 1 and 2.

Note: For punch operations, if a format control program positions data beyond column 80 (129 Data Recorder) or column 96 (5496 Data Recorder) in the buffer, that data is not punched and no error is displayed.

Card Read/Punch Format Instruction Set

The card read/punch format instruction set is a group of read/punch format control characters that provide information for formatting records. The control characters and their meanings are as follows:

Control Character	Meaning
N&	Identifies card read/punch format programs: All card read/punch format programs must have a N& (ampersand) in positions 1 and 2.
xA	Format data field: Loads the output buffer from the input buffer with the number of characters specified by the number preceding the A format control character.
xB	Format data field with suppression of leading zeros: Loads the output buffer from the input buffer with the number of characters specified by the number preceding the B format control character, but loads blanks instead of leading zeros. <i>(Note: Blanks in the input buffer are treated as significant digits, not as zeros, and therefore will stop zero suppression.)</i>
XX	Skip characters from the output buffer: Skips over, with no action, the number of characters in the output buffer specified by the number preceding the X format control character. <i>(Note: It is not permissible to skip beyond buffer position 128.)</i>

Control Character	Meaning
xY	Skips characters from the input buffer: Skips over, with no action, the number of characters in the input buffer specified by the number preceding the Y format control character. <i>(Note: It is not permissible to skip beyond buffer position 128.)</i>
xF	Reverse skips characters from the input buffer. Skips over, in reverse direction (towards position 1) with no action, the number of characters in the input buffer specified by the number preceding the F format control character. <i>(Note: It is not permissible to reverse skip beyond buffer position 1.)</i>
xl	Insert characters: Loads the characters following the l into the output buffer. The number preceding the l format control character indicates the number of characters to be loaded to the buffer.
C	Read or punch a card: A card is read or punched without advancing to the next disk record. <i>Note: The pointers in the input buffer and the output buffer are reset to position one each time a C is encountered in the format control program. That is, when the format control program contains the format control character C, the format control defined after the C must start from position one of the buffers. See <i>How Format Control Works</i>, examples 4 and 5, for more information on the C format control character.</i>
N or blank	No-op: No operation is performed.
Q	Read or punch a card and terminate the format program: This format control character must be used at the end of every format program.

Notes:

- As it is used in the preceding chart, x represents a variable value (from 1 to 128) that is the multiple of the control characters to be executed. If a control character is preceded by a blank, N, O, or another control character, the multiple is assumed to be one.
- If an A or B control character causes the input buffer pointer to move to position 129, the F control character can be used to correct the boundary violation.

FUNCTION SWITCHES

Figures 69 and 70 identify which positions the data recorder function switches must be in, when the data recorder is on-line with the 3741.

Switch	Required Position
Program	Off
Auto Record Release	Auto
Print	On (To allow printing) Off (No printing)
Punch/Verify	Punch
Terminal/Manual	Terminal

Figure 69. 5496 Data Recorder Switch Positions

Switch	Required Position
Print	On (To allow printing) Off (No printing)
Punch/Verify	Punch
Record Advance/Card Feed	Auto
Program Mode Dial	Data Read
Read (Pushbutton)	Must not be pressed
Record Backspace	Must not be operated
Clear	Used only for error recovery
Auto Skip/Dup	Optional
Character Mode	Optional
SPL Feature	On

Figure 70. 129 Data Recorder Switch Positions

HOW FORMAT CONTROL WORKS

Figures 71 and 72 show the data flow, when using format control, for reading or punching cards with the data recorder attachment feature.

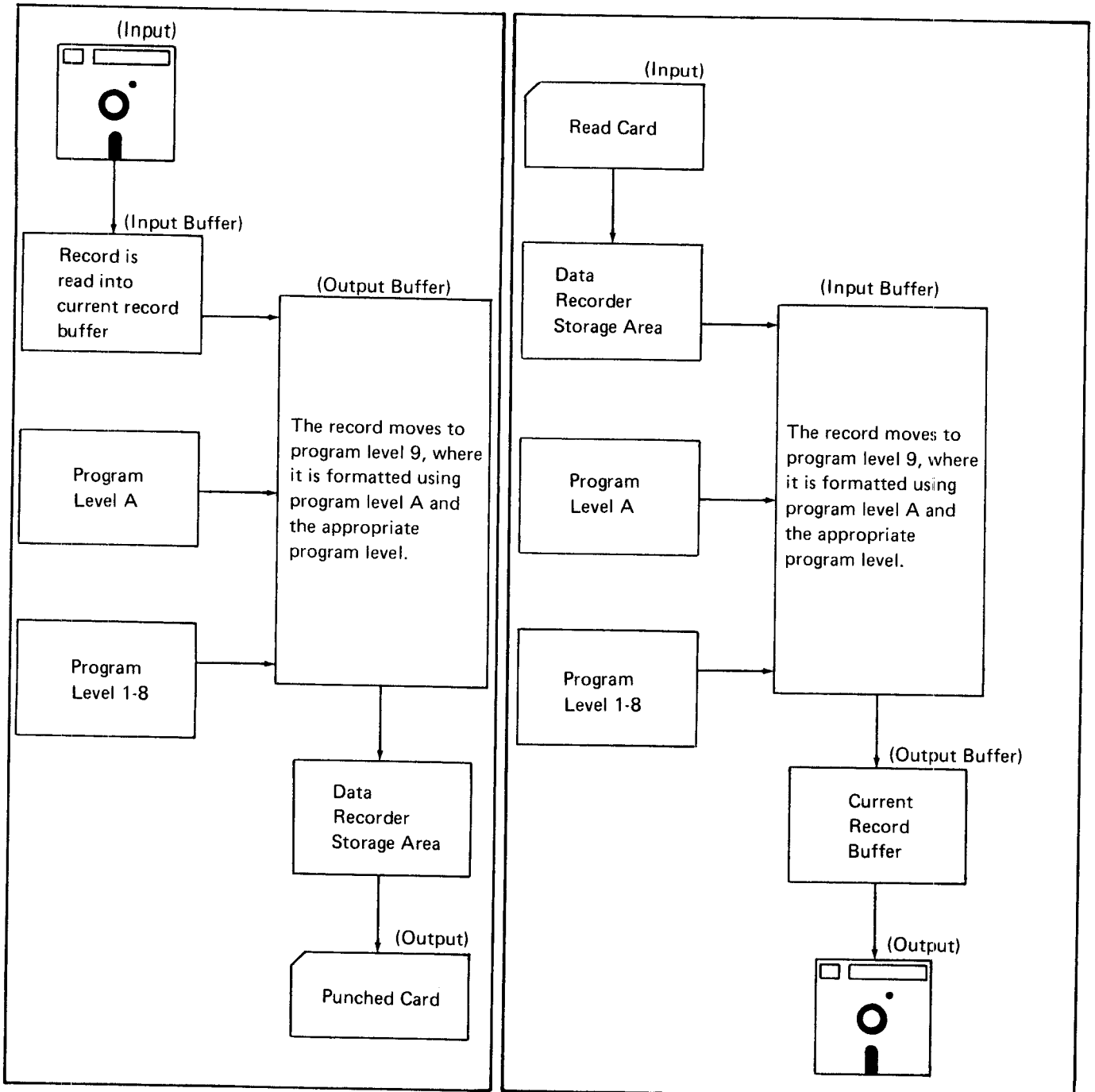

Figure 71. Data Flow When Punching Cards with Format Control Figure 72. Data Flow When Reading Cards with Format Control

Figure 73 shows the data flow when formatting the record in the current record buffer.

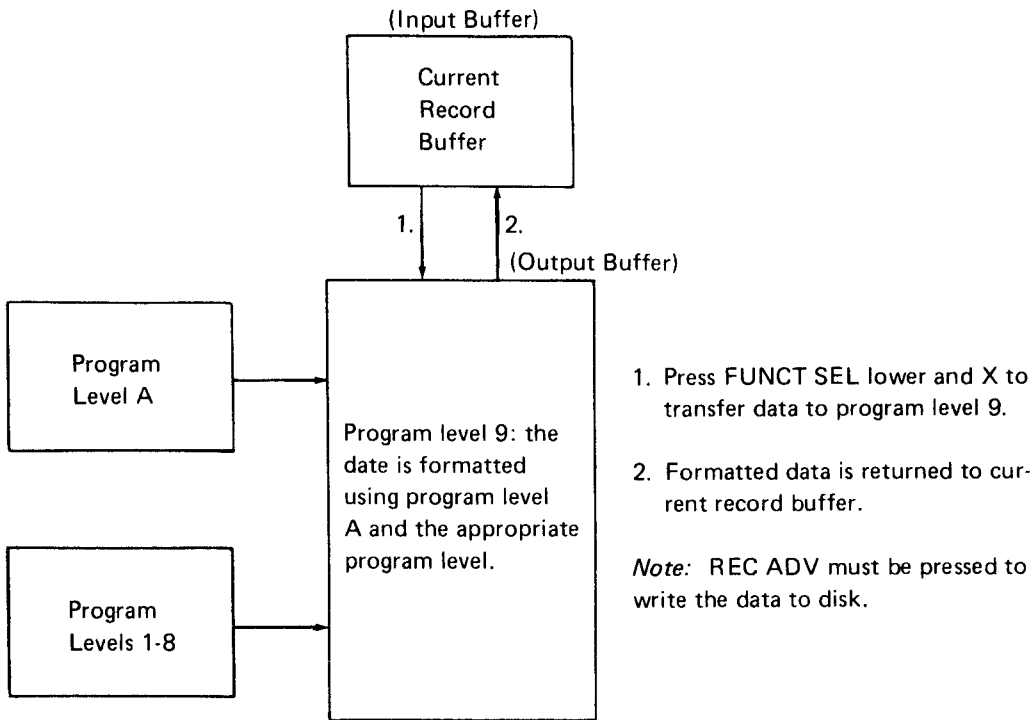

Figure 73. Data Flow When Formatting Current Record Buffer

Format Control Examples

Example 1 - Manual Selection of Format Control Programs

Program level A contains:

1 2 3 4 5 6 7 8 9 → position in program level A

(Colon)

④

indicates the program level used if a read/punch operation is initiated, while program level 5 is selected for entering or updating data on disk. (See Program Level A for more information on selecting format control programs.)

Program level 4 contains:

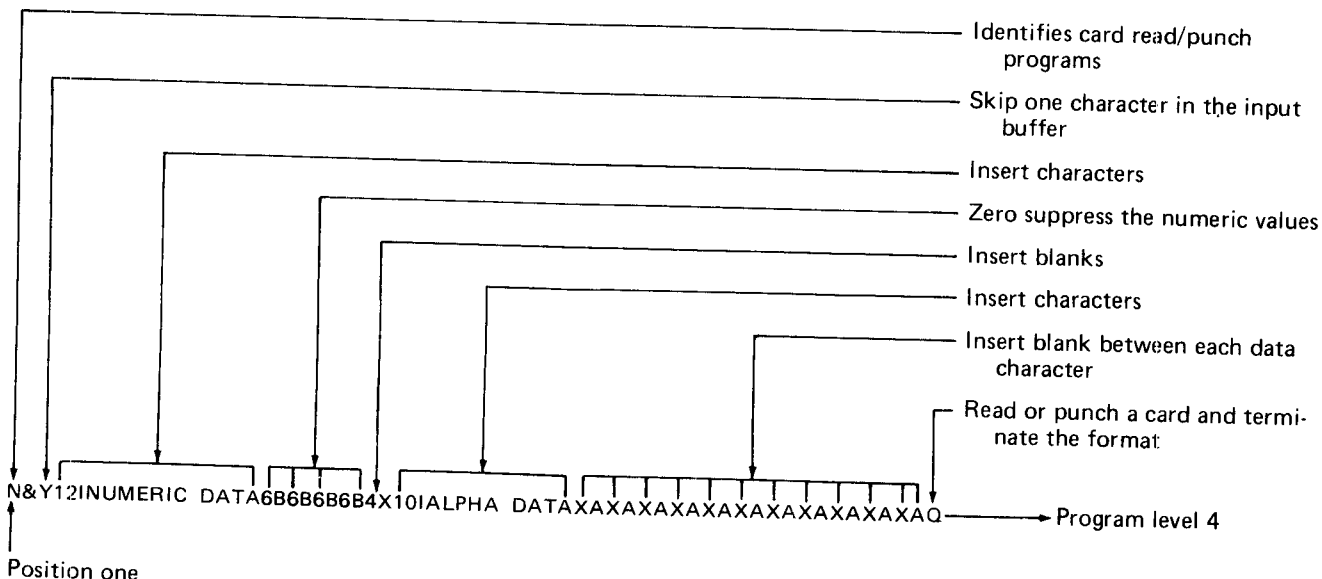

In this example, assume the operator has manually selected program level 5 and is keying data. When the operator initiates a read or punch operation, program 4 is automatically used for that operation. Following is an example of an input record and the formatted output record.

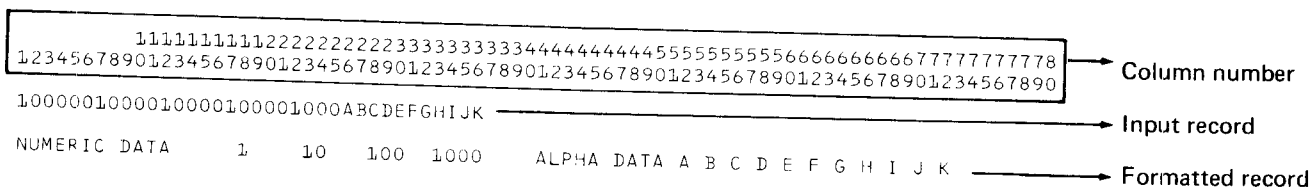

After the read or punch operation is complete, the 3741 returns to its previous mode and program level 5 is again active.

Example 2 - Automatic Selection of Format Control Programs

Program level A contains:

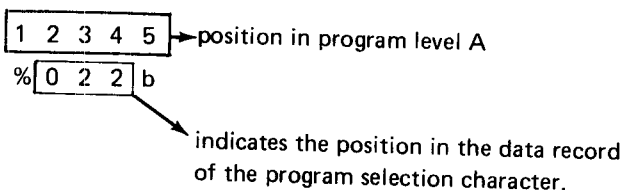

Program level 1 contains:

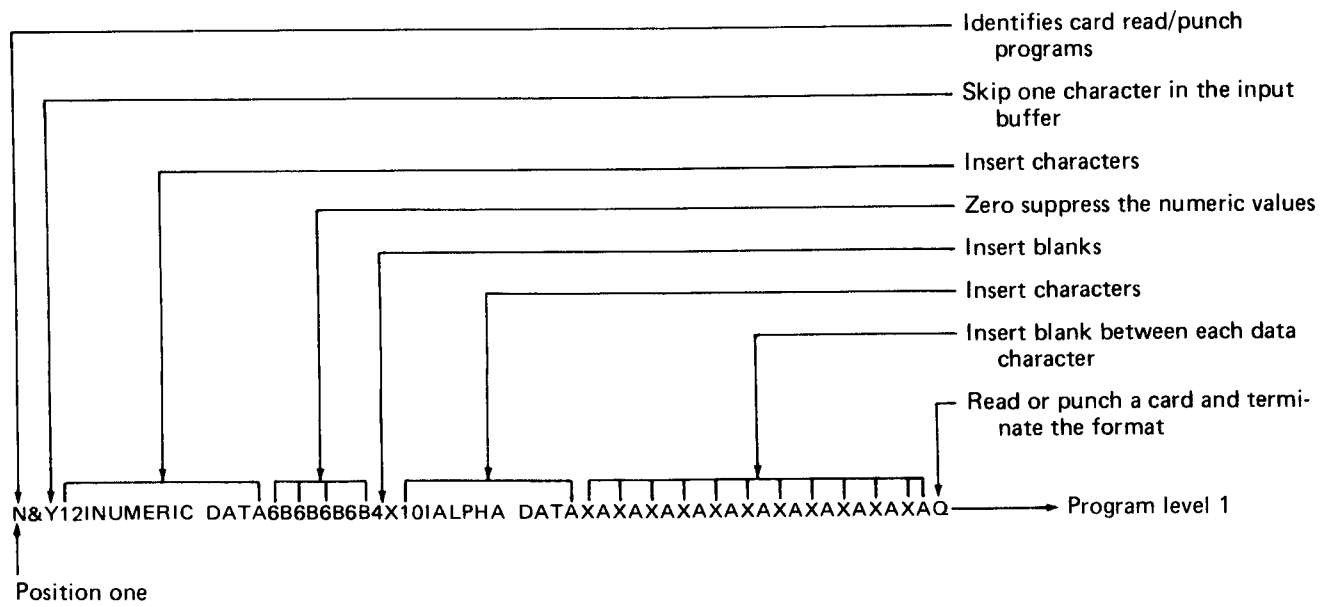

In this example, when the operator initiates a read or punch operation, position 22 of the input record defines the program level used for formatting. Following is an example of an input record and the formatted output record.

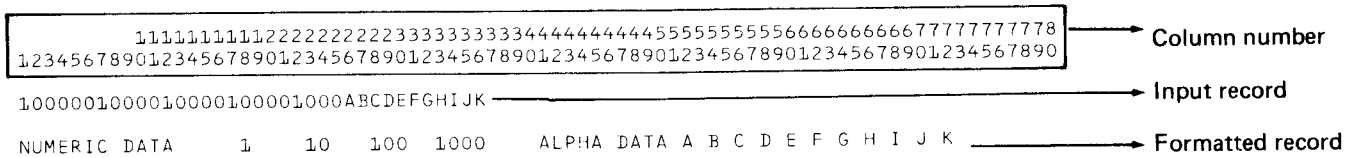

Example 3 - Using the C Format Control Character While Punching

In this example, the format control program selected is as follows:

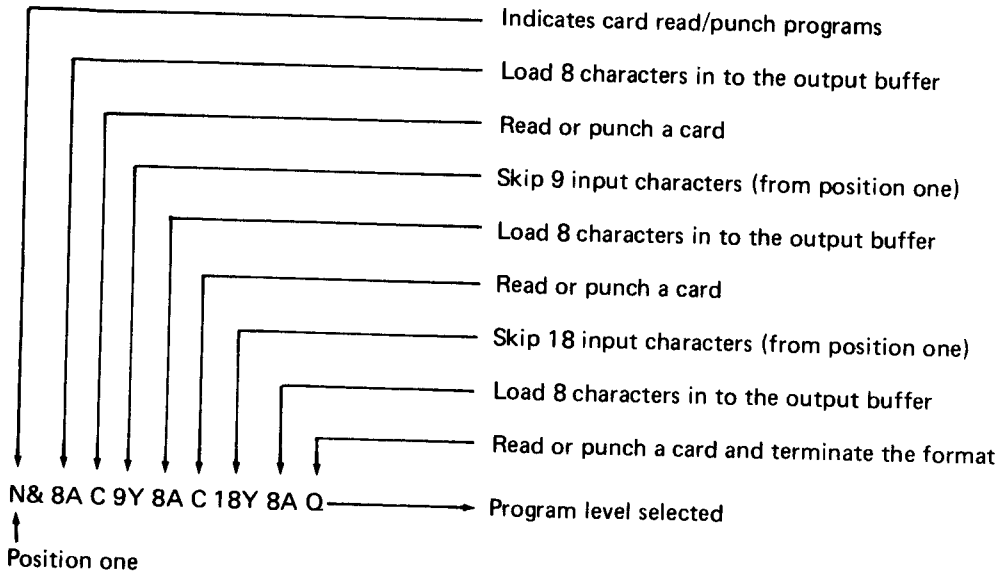

If the operator initiates a punch operation with the following record being displayed,

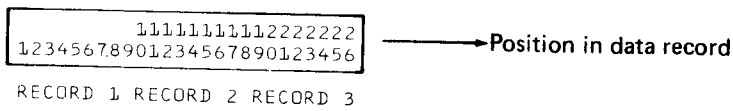

then the punch operation punches three cards as follows:

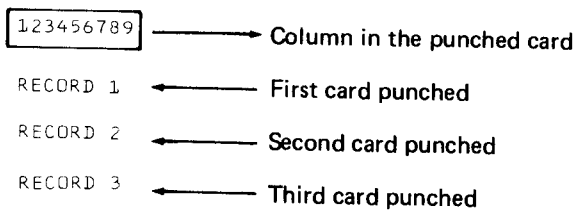

Example 4 - Using the C Format Control Character While Reading

In this example, the format control program selected is as follows:

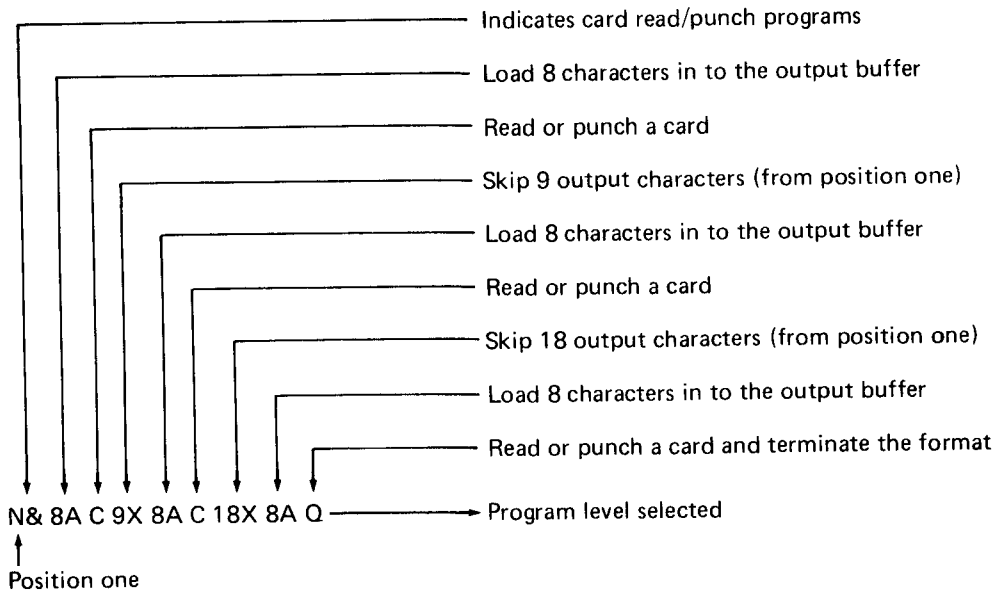

If the operator initiates a read operation with the following three cards in the data recorder

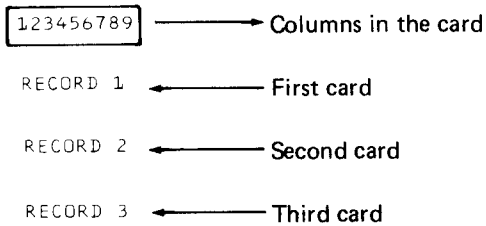

the read operation places the following data in the buffer:

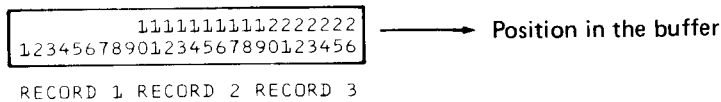

Example 5 - Formatting the Record in the Current Record Buffer

In this example, the format control program selected is as follows:

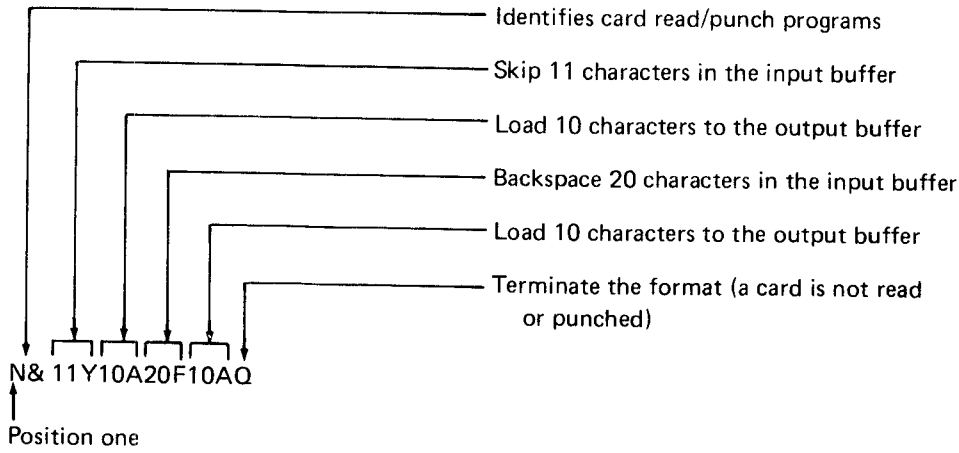

Following is an example of a record in the current record buffer that is formatted using the previous format control program.

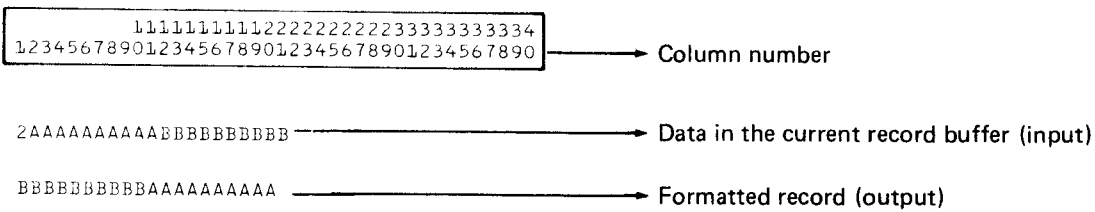

Chapter 14. I/O Adapter

The 3741 I/O adapter provides a high-speed method of entering diskette data directly into a system or of building diskette storage files directly from a system.

The I/O adapter and the data recorder attachment feature are mutually exclusive.

The I/O adapter transfers data by either reading or writing. Reading transfers data from the system to the 3741; writing transfers data from the 3741 to the system. Reading and writing, as defined in the reference manual of the system in communication with the 3741, may be exactly opposite due to the direction from which data is entering or exiting the particular device.

When the I/O adapter is reading, the data is transferred at an approximate rate of 1000 records per minute. When writing, the data is transferred at an approximate rate of 1500 records per minute. These data rates are the capability of the 3741 I/O adapter, but not necessarily the actual data rates when connected to a system; the determining factor is the data transfer rate of the system. See the reference manual for the system for the actual data transfer rate of each mode of operation.

The basic functions of the data station do not change with the installation of the I/O adapter. During data transfer operations, while the 3741 is actually communicating with the system, the keyboard is disabled except for the NUM SHIFT, ALPHA SHIFT, and RESET keys. These keys remain enabled to allow terminating an operation, although terminating an operation by using these keys is not recommended as a normal procedure because data may be lost in the process. The normal termination procedure associated with most of the operations allows for completion of the data transfer before the operation is terminated. After the 3741 is done communicating with the system, the keyboard will again be enabled before termination of the operation. When the I/O adapter is not transferring data and the keyboard is enabled, the 3741 can be used for basic data entry jobs.

Operations are terminated in three ways:

1. **Manual** — At a point in the transfer operation when operator action is expected and the keyboard is enabled, the operator can press FUNCT SEL upper and

T to end the operation. If the 3741 is not in a wait state at that time, the operator must first enter the device address of the system in position 1 before pressing these keys. Manual termination should not be used when reading.

2. **Automatic** — At the end of some operations, the data transfer terminates automatically.
3. **Immediate** — At any time, in an emergency situation, the operator can terminate an operation by pressing both NUM SHIFT and ALPHA SHIFT while pressing RESET. However, some records may not complete the transfer from buffer to diskette.

You can transfer data beginning with any sector of a track and ending with any sector of a track (deleted records are ignored). The data transferred is referred to as a file of data. A file can consist of multiple data sets residing on one or more diskettes. Records in a data set may be any length from 1 to 128 characters, but the record length cannot vary within a file.

Since multiple data sets can reside on a diskette, you must ensure that the extents of the data sets do not overlap. The I/O adapter checks for overlapping extents, but does not check for deleted or bypassed data sets. Sectors which are deleted or which contain a sequential bad spot will also be bypassed.

Dual disk capability provided on the 3741 is useful with the installation of the I/O adapter feature when doing a file transfer. Dual disk enables you to concatenate data on one file from two diskettes when writing and also increases the amount of data that can be transferred without operation intervention.

FILE TRANSFER

Data transfer by file is based on the extents in the data set label and the selected mode of operation. The I/O adapter checks the data set label for the following:

- Positions 1 through 3 must contain HDR
- Position 41 must not contain a B for bypass
- Positions 29 through 39 do not overlap the extents of the other data sets on this same diskette

The remainder of the data set label checking is done by the base 3741. A bypassed data set will be skipped during a read or write data transfer; however, if the bypassed data set is the first one to be transferred, and the operation is to begin from the index track, the data transfer operation will not start. The error condition which results from a bypassed data set can be reset by the operator if so desired and processing continued. A write-protected data set will be skipped during a read operation; it also will prevent the start of data transfer during a read operation if the write-protected data set is the first data set to be transferred.

Five modes of file transfer operations can be selected for either reading or writing:

- Mode 1:** Single data set transfer
- Mode 2:** Multiple data set transfer, by single data set under operator control
- Mode 3:** Multiple data set transfer, continuous with EOD indicator between data sets
- Mode 4:** Multiple data set transfer, continuous with operator-selected EOD and EOJ records
- Mode 5:** Multiple data set transfer, combining consecutive data sets with no EOD indicators unless an L is entered by the operator

Each of the modes can start from the index track or from within a data set and are initiated by the following procedure:

1. Enter the device address of the system in position 1.
2. Enter the mode of operation (such as a 1, 2, etc) in position 2.
3.
 - a. Press FUNCT SEL upper and DUP (OUTPUT) for a write operation, or
 - b. Press FUNCT SEL upper and FIELD COR (INPUT) for a read operation.

Mode 1

The single data set transfer mode, using a single disk drive, transfers data until an EOD (end of data) is encountered. The EOD causes termination of the operation, an EOJ (end of job) is sent, and the read/write head then returns to the index track. The only difference between reading or writing in mode 1 is that the read operation has to update the EOD field in the data set label before the 3741 goes off-line.

If the EOE (end of extent) is reached, and there is more data to be transferred, one more record will be received from the system and stored in program buffer A. An error will be posted to indicate this condition, and the 3741 will wait for an operator response. Holding ALPHA SHIFT and pressing RESET, holding NUM SHIFT and pressing RESET, or pressing RESET can be used to clear the error and will leave the 3741 online, allowing recovery of the last record of data. To recover the last record received and continue processing the remainder of records, the operator can (1) extend the data set, search to EOD, press REC ADV, and restart; (2) position to another data set label and continue the operation after keying the initiating sequence; or (3) insert another disk and follow the procedure in (2). Upon continuation of the operation, the record saved in program buffer A will be the first record written to the diskette. It is the operator's responsibility not to modify or destroy the record in program buffer A.

If holding both ALPHA SHIFT and NUM SHIFT while pressing RESET is used to clear the previously described soft error, the 3741 is taken offline, and the record in program buffer 10 is lost.

The procedure for recovering the last record can also be used in modes 2 and 5 if the EOE is reached before all of the data has been transferred by the system.

Mode 2

This mode of operation also uses only a single disk drive. The difference in operation between modes 1 and 2 is that in mode 2 the 3741 does not go offline after a single data set has been transferred, but instead remains in a wait state expecting another data set transfer to be initiated. The read operation again updates the data set label with the correct EOD after each data set is transferred. Each transfer of a data set must be reinitiated by keying a 2 in position 2 if the transfer of data is to be continued beyond that data set. When the data set to be transferred is the last one, keying a 1 in position 2 instead of a 2 will cause the 3741 to automatically terminate the operation with an EOJ (end of job). However, if the last data set was transferred without keying a 1 in position 2, the operation will have to be terminated manually: by entering the device address and pressing FUNCT SEL upper and T, which will send the EOJ to the system and terminate the operation.

Mode 3

Mode 3 can use both disk drives. It transfers data continuously with no wait between data sets. When the EOD is encountered, an EOD indicator is sent to the system when writing or received from the system when reading. C in

position 45 of the diskette label (the multivolume indicator) indicates data continued on another disk; L or blank indicates that this diskette contains the end of the continued data set. When writing data, the 3741 checks the multivolume indicator; when it encounters a C, the data set is continued with the first valid data set on the next disk. When the 3741 encounters an L or blank, the transfer of data continues with the next valid data set on this diskette. When reading, the 3741 generates a C or L in the multivolume indicator as data is sent from the system to the 3741.

Transfer of data can continue back-and-forth between drives or with additional diskettes in drive 1 if drive 2 is not ready at the time it is addressed. If drive 2 is not ready, the 3741 will post a message indicating it is now ready to accept another diskette in drive 1. You can then either insert a new diskette in drive 1 and press RESET to continue or manually terminate the operation.

Writing in mode 3 does not terminate automatically; therefore, when you are done transferring data, you will have to manually terminate the operation. In reading, the EOJ is automatic.

Mode 4

Mode 4 is the same as mode 3 except for the EOD and EOJ indicator records generated. In mode 4, a special record is sent to or received from the system at the end of a data set. To produce this special record, you must, when initiating this mode, enter a 3-character line-ending sequence (for example, XYZ) in positions 3 through 5, in addition to the entries in positions 1 and 2. The special EOD and EOJ indicators can be whatever valid character sequence you choose. When writing and an EOD is encountered, one more record will be transferred, containing, in this case, the XY characters in the first two positions and blanks in the rest of the record. This procedure continues with each data set until you manually terminate the operation. Then, at EOJ, one more record will be transferred, containing, in this case, the XZ characters in the first two positions and blanks in the rest of the record. When reading a file of data in mode 4, the XY and XZ characters in a record will cause an EOD and EOJ.

Mode 5

When writing in this mode, a blank or a C in the multivolume indicator field means that the data set is continued on the next valid HDR1 label. This label can be the next data set on the same diskette or on another diskette. The system assumes that all the data sets sent are one until an L in the multivolume indicator field is encountered. The L causes the EOD to be sent to the system and data transfer resumes with the next valid data set.

When reading, data is read continuously from the system to the diskette, starting with the first valid data set on the diskette and continuing until an EOD is received from the system. The 3741 will then go to the next valid data set on that diskette and continue to process data. When the last data set defined on that diskette has been processed, processing can continue with another diskette on the other drive, if it is ready. If the other drive is not ready, a message will be posted, and control can continue on drive 1.

Mode 5 is an operation very similar to that of the 3747 diskette-to-tape job.

The following table provides a summary of file transfer modes:

Summary of File Transfer Operations (Read or Write)

Mode	Drive	Termination	Writing (3741 to System)	Reading (System to 3741)
1	1	Automatic	Single data set only	Single data set only
2	1	Manual: FUNCT SEL upper, T Use mode 1 on last data set for automatic termination Automatic at EOJ when reading	Multiple data sets with operator intervention between data sets. Operator can position disk to next data set and continue.	Multiple data sets with operator intervention between data sets. Each data set is automatically closed. Operator can position to next data set and continue.
3	1 or 2	Manual: FUNCT SEL upper, T Automatic at EOJ when reading	Multiple data sets processed automatically. The multivolume indicator of the label controls when the end of a data set is indicated. A blank or L indicates the end of a data set, a C causes data from the next disk (drive 1 or 2) to be sent as part of the same data set.	Multiple data sets are processed automatically. The multivolume indicator of the label is updated along with the EOD address. A blank is inserted if the data is contained on one disk, a C is inserted if the data is continued on another disk, and an L is inserted in the last data set label of continued data. Continuation to drive 2 or back to drive 1 is automatic if these drives are made ready at the proper times.
4	1 or 2	Manual: FUNCT SEL upper, T Automatic at XZ message when reading	Multiple data sets processed automatically as in mode 3 except for special records inserted by the 3741. These records are created as a result of an operator action. During job setup, the characters XYZ are entered on the display. At the end of a data set, a record with XY is sent to the system. At the end of job, a record with XZ is sent.	Multiple data sets are processed automatically, as in mode 3. The 3741 will recognize special end-of-data and end-of-job records indicated by operator options.
5	1 or 2	Manual: FUNCT SEL upper, T Automatic at EOJ when reading	Multiple data sets processed automatically in a similar manner to a diskette to tape job on the 3747. A blank or C in the multivolume indicator of the label causes the next data set on this disk or the next disk to be sent as part of the current data set. An L causes an end-of-data indicator to be sent to the system.	Multiple data sets processed automatically similar to tape to diskette job on the 3747. No changes are made to the multivolume indicator of the label when the end-of-data indicator is received from the system. If EOE is reached before an end-of-data indicator, the operator can continue to receive by readying another label.

ERROR RECOVERY PROCEDURES

The errors that can occur while the I/O adapter is functioning are displayed in positions 7 through 10 on the display. Errors displayed in positions 7 and 8 are disk errors; errors displayed in positions 9 and 10 are system channel errors.

Disk Errors

There are four types of disk errors:

- Basic disk errors
- Label checks
- Dataset checks
- Drive switching checks

Some disk errors are recoverable and some are not. For a complete listing of the errors and a recovery procedure, refer to the *IBM 3741 Data Station Operator's Guide*, GA21-9131.

System Channel Errors

System channel errors are not recoverable, except for error code 86. When an error occurs, the operation will have to be aborted by holding both ALPHA SHIFT and NUM SHIFT while pressing RESET. Any data files which were open at the time the error occurred are left open and the data lost. The data will have to be reconstructed and the operation completely restarted. For error code 86, refer to the *IBM 3741 Data Station Operator's Guide*, GA21-9131.

Appendix A. Timings

The following chart provides approximate timing information for search, copy, and initialization operations on the 3741. Timings are shown for the normal sector sequence (1, 2, 3, 25, 26) and for the alternate sector sequence (1,3,5, 25, 2, 4, 24, 26). The timings provided in the chart should serve as a useful guide when relative job timing must be considered.

The timings are based on 80 character records. Timing can be affected by such things as disk speed, length and location of search masks, and the location of data sets on the disk.

OPERATION	NUMBER OF RECORDS	NORMAL SECTOR SEQUENCE		ALTERNATE SECTOR -- SEQUENCE	
		DISK 1	DISK 2	DISK 1	DISK 2
Search end of data	1898 (assume EOD is 74001)	5 sec	5 sec	5 sec	5 sec
	949 (assume EOD is 37014)	3 sec	3 sec	3 sec	3 sec
	400 (assume EOD is 16001)	2 sec	2 sec	2 sec	2 sec
Search on sequential content	1898	30 sec	8 sec	30 sec	8 sec
	949	15 sec	8 sec	15 sec	8 sec
	400	8 sec	8 sec	7 sec	7 sec
Search on content	1898	5 min 30 sec	5 min 30 sec	2 min 50 sec	8 min
	949	2 min 45 sec	2 min 45 sec	1 min 30 sec	4 min
	400	1 min 10 sec	1 min 10 sec	40 sec	1 min 45 sec
Disk initialization	-----	1 min 50 sec	-----	1 min 50 sec	-----
Image copy	1898 plus index track	3 min 30 sec	-----	10 min	-----
Data set copy	949	10 min	-----	9 min	-----
Data set copy	400	4 min 30 sec	-----	3 min 50 sec	-----

Appendix B. Card Punch to Hexadecimal Conversion

Card Punch to Hex Conversion (in Hexadecimal Order)

HEX	CARD PUNCH	HEX	CARD PUNCH	HEX	CARD PUNCH	HEX	CARD PUNCH
00	12-0-1-8-9	40	NO PUNCHING	80	12-0-1-8	C0	12-0
01	12-1-9	41	12-0-1-9	81	12-0-1	C1	12-1
02	12-2-9	42	12-0-2-9	82	12-0-2	C2	12-2
03	12-3-9	43	12-0-3-9	83	12-0-3	C3	12-3
04	12-4-9	44	12-0-4-9	84	12-0-4	C4	12-4
05	12-5-9	45	12-0-5-9	85	12-0-5	C5	12-5
06	12-6-9	46	12-0-6-9	86	12-0-6	C6	12-6
07	12-7-9	47	12-0-7-9	87	12-0-7	C7	12-7
08	12-8-9	48	12-0-8-9	88	12-0-8	C8	12-8
09	12-1-8-9	49	12-1-8	89	12-0-9	C9	12-9
0A	12-2-8-9	4A	12-2-8	8A	12-0-2-8	CA	12-0-2-8-9
0B	12-3-8-9	4B	12-3-8	8B	12-0-3-8	CB	12-0-3-8-9
0C	12-4-8-9	4C	12-4-8	8C	12-0-4-8	CC	12-0-4-8-9
0D	12-5-8-9	4D	12-5-8	8D	12-0-5-8	CD	12-0-5-8-9
0E	12-6-8-9	4E	12-6-8	8E	12-0-6-8	CE	12-0-6-8-9
0F	12-7-8-9	4F	12-7-8	8F	12-0-7-8	CF	12-0-7-8-9
10	12-11-1-8-9	50	12	90	12-11-1-8	D0	11-0
11	11-1-9	51	12-11-1-9	91	12-11-1	D1	11-1
12	11-2-9	52	12-11-2-9	92	12-11-2	D2	11-2
13	11-3-9	53	12-11-3-9	93	12-11-3	D3	11-3
14	11-4-9	54	12-11-4-9	94	12-11-4	D4	11-4
15	11-5-9	55	12-11-5-9	95	12-11-5	D5	11-5
16	11-6-9	56	12-11-6-9	96	12-11-6	D6	11-6
17	11-7-9	57	12-11-7-9	97	12-11-7	D7	11-7
18	11-8-9	58	12-11-8-9	98	12-11-8	D8	11-8
19	11-1-8-9	59	11-1-8	99	12-11-9	D9	11-9
1A	11-2-8-9	5A	11-2-8	9A	12-11-2-8	DA	12-11-2-8-9
1B	11-3-8-9	5B	11-3-8	9B	12-11-3-8	DB	12-11-3-8-9
1C	11-4-8-9	5C	11-4-8	9C	12-11-4-8	DC	12-11-4-8-9
1D	11-5-8-9	5D	11-5-8	9D	12-11-5-8	DD	12-11-5-8-9
1E	11-6-8-9	5E	11-6-8	9E	12-11-6-8	DE	12-11-6-8-9
1F	11-7-8-9	5F	11-7-8	9F	12-11-7-8	DF	12-11-7-8-9
20	11-0-1-8-9	60	11	A0	11-0-1-8	E0	0-2-8
21	0-1-9	61	0-1	A1	11-0-1	E1	11-0-1-9
22	0-2-9	62	11-0-2-9	A2	11-0-2	E2	0-2
23	0-3-9	63	11-0-3-9	A3	11-0-3	E3	0-3
24	0-4-9	64	11-0-4-9	A4	11-0-4	E4	0-4
25	0-5-9	65	11-0-5-9	A5	11-0-5	E5	0-5
26	0-6-9	66	11-0-6-9	A6	11-0-6	E6	0-6
27	0-7-9	67	11-0-7-9	A7	11-0-7	E7	0-7
28	0-8-9	68	11-0-8-9	A8	11-0-8	E8	0-8
29	0-1-8-9	69	0-1-8	A9	11-0-9	E9	0-9
2A	0-2-8-9	6A	12-11	AA	11-0-2-8	EA	11-0-2-8-9
2B	0-3-8-9	6B	0-3-8	AB	11-0-3-8	EB	11-0-3-8-9
2C	0-4-8-9	6C	0-4-8	AC	11-0-4-8	EC	11-0-4-8-9
2D	0-5-8-9	6D	0-5-8	AD	11-0-5-8	ED	11-0-5-8-9
2E	0-6-8-9	6E	0-6-8	AE	11-0-6-8	EE	11-0-6-8-9
2F	0-7-8-9	6F	0-7-8	AF	11-0-7-8	EF	11-0-7-8-9
30	12-11-0-1-8-9	70	12-11-0	B0	12-11-0-1-8	F0	0
31	1-9	71	12-11-0-1-9	B1	12-11-0-1	F1	1
32	2-9	72	12-11-0-2-9	B2	12-11-0-2	F2	2
33	3-9	73	12-11-0-3-9	B3	12-11-0-3	F3	3
34	4-9	74	12-11-0-4-9	B4	12-11-0-4	F4	4
35	5-9	75	12-11-0-5-9	B5	12-11-0-5	F5	5
36	6-9	76	12-11-0-6-9	B6	12-11-0-6	F6	6
37	7-9	77	12-11-0-7-9	B7	12-11-0-7	F7	7
38	8-9	78	12-11-0-8-9	B8	12-11-0-8	F8	8
39	1-8-9	79	1-8	B9	12-11-0-9	F9	9
3A	2-8-9	7A	2-8	BA	12-11-0-2-8	FA	12-11-0-2-8-9
3B	3-8-9	7B	3-8	BB	12-11-0-3-8	FB	12-11-0-3-8-9
3C	4-8-9	7C	4-8	BC	12-11-0-4-8	FC	12-11-0-4-8-9
3D	5-8-9	7D	5-8	BD	12-11-0-5-8	FD	12-11-0-5-8-9
3E	6-8-9	7E	6-8	BE	12-11-0-6-8	FE	12-11-0-6-8-9
3F	7-8-9	7F	7-8	BF	12-11-0-7-8	FF	12-11-0-7-8-9

Card Punch to Hex Conversion (in Card Punch Order)

CARD PUNCH	HEX	CARD PUNCH	HEX	CARD PUNCH	HEX	CARD PUNCH	HEX
0-1	61	0-5	E5	1	F1	5	F5
0-1-8	69	0-5-8	6D	1-8	79	5-8	7D
0-1-8-9	29	0-5-8-9	2D	1-8-9	39	5-8-9	3D
0-1-8-9-11	20	0-5-8-9-11	ED	1-8-9-11	19	5-8-9-11	1D
0-1-8-9-11-12	30	0-5-8-9-11-12	FD	1-8-9-11-12	10	5-8-9-11-12	DD
0-1-8-9-12	00	0-5-8-9-12	CD	1-8-9-12	09	5-8-9-12	0D
0-1-8-11	A0	0-5-8-11	AD	1-8-11	59	5-8-11	5D
0-1-8-11-12	B0	0-5-8-11-12	BD	1-8-11-12	90	5-8-11-12	9D
0-1-8-12	80	0-5-8-12	8D	1-8-12	49	5-8-12	4D
0-1-9	21	0-5-9	25	1-9	31	5-9	35
0-1-9-11	E1	0-5-9-11	65	1-9-11	11	5-9-11	15
0-1-9-11-12	71	0-5-9-11-12	75	1-9-11-12	51	5-9-11-12	55
0-1-9-12	41	0-5-9-12	45	1-9-12	01	5-9-12	05
0-1-11	A1	0-5-11	A5	1-11	D1	5-11	D5
0-1-11-12	B1	0-5-11-12	B5	1-11-12	91	5-11-12	95
0-1-12	81	0-5-12	85	1-12	C1	5-12	C5
0-2	E2	0-6	E6	2	F2	6	F6
0-2-8	E0	0-6-8	6E	2-8	7A	6-8	7E
0-2-8-9	2A	0-6-8-9	2E	2-8-9	3A	6-8-9	3E
0-2-8-9-11	EA	0-6-8-9-11	EE	2-8-9-11	1A	6-8-9-11	1E
0-2-8-9-11-12	FA	0-6-8-9-11-12	FE	2-8-9-11-12	DA	6-8-9-11-12	DE
0-2-8-9-12	CA	0-6-8-9-12	CE	2-8-9-12	0A	6-8-9-12	0E
0-2-8-11	AA	0-6-8-11	AE	2-8-11	5A	6-8-11	5E
0-2-8-11-12	BA	0-6-8-11-12	BE	2-8-11-12	9A	6-8-11-12	9E
0-2-8-12	9A	0-6-8-12	8E	2-8-12	4A	6-8-12	4E
0-2-9	22	0-6-9	26	2-9	32	6-9	36
0-2-9-11	62	0-6-9-11	66	2-9-11	12	6-9-11	16
0-2-9-11-12	72	0-6-9-11-12	76	2-9-11-12	52	6-9-11-12	56
0-2-9-12	42	0-6-9-12	46	2-9-12	02	6-9-12	06
0-2-11	A2	0-6-11	A6	2-11	D2	6-11	D6
0-2-11-12	B2	0-6-11-12	B6	2-11-12	92	6-11-12	96
0-2-12	82	0-6-12	86	2-12	C2	6-12	C6
0-3	E3	0-7	E7	3	F3	7	F7
0-3-8	6B	0-7-8	6F	3-8	7B	7-8	7F
0-3-8-9	2B	0-7-8-9	2F	3-8-9	3B	7-8-9	3F
0-3-8-9-11	EB	0-7-8-9-11	EF	3-8-9-11	1B	7-8-9-11	1F
0-3-8-9-11-12	FB	0-7-8-9-11-12	FF	3-8-9-11-12	DB	7-8-9-11-12	DF
0-3-8-9-12	CB	0-7-8-9-12	CF	3-8-9-12	0B	7-8-9-12	0F
0-3-8-11	AB	0-7-8-11	AF	3-8-11	5B	7-8-11	5F
0-3-8-11-12	BB	0-7-8-11-12	BF	3-8-11-12	9B	7-8-11-12	9F
0-3-8-12	8B	0-7-8-12	8F	3-8-12	4B	7-8-12	4F
0-3-9	23	0-7-9	27	3-9	33	7-9	37
0-3-9-11	63	0-7-9-11	67	3-9-11	13	7-9-11	17
0-3-9-11-12	73	0-7-9-11-12	77	3-9-11-12	53	7-9-11-12	57
0-3-9-12	43	0-7-9-12	47	3-9-12	03	7-9-12	07
0-3-11	A3	0-7-11	A7	3-11	D3	7-11	D7
0-3-11-12	B3	0-7-11-12	B7	3-11-12	93	7-11-12	97
0-3-12	83	0-7-12	87	3-12	C3	7-12	C7
0-4	E4	0-8	E8	4	F4	8	F8
0-4-8	6C	0-8-9	28	4-8	7C	8-9	38
0-4-8-9	2C	0-8-9-11	68	4-8-9	3C	8-9-11	18
0-4-8-9-11	EC	0-8-9-11-12	78	4-8-9-11	1C	8-9-11-12	58
0-4-8-9-11-12	FC	0-8-9-12	48	4-8-9-11-12	DC	8-9-12	08
0-4-8-9-12	CC	0-8-11	A8	4-8-9-12	0C	8-11	D8
0-4-8-11	AC	0-8-11-12	B8	4-8-11	5C	8-11-12	98
0-4-8-11-12	BC	0-8-12	8B	4-8-11-12	9C	8-12	C8
0-4-8-12	8C	0-9	E9	4-8-12	4C	9	F9
0-4-9	24	0-9-11	A9	4-9	34	9-11	D9
0-4-9-11	64	0-9-11-12	B9	4-9-11	14	9-11-12	99
0-4-9-11-12	74	0-9-12	89	4-9-11-12	54	9-12	C9
0-4-9-12	44	0	F0	4-9-12	04	11	60
0-4-11	A4	0-11	D0	4-11	D4	11-12	6A
0-4-11-12	B4	0-11-12	70	4-11-12	94	12	50
0-4-12	84	0-12	C0	4-12	C4	NO PUNCHES	40

Glossary

Accumulator: A counting device that retains an accumulated sum until reset.

Alpha shift: The A and Z keys plus the bottom letters on all the other keys.

Alphanumeric: Any of the 26 characters of the alphabet or 10 numeric digits 0 through 9.

Automatic field: A field that is completed by the machine automatically such as an auto dup or auto skip field which the operator does not have to key manually.

Begin field code: Synonymous with field definition character.

Blank character: An unused character position in a record. Results when the space bar is pressed.

BOE (beginning of extent): The beginning of a data set, defined by a track and sector number; pertains to positions 29 through 33 in the data set label.

Bypass: Moving the cursor across a field or portion of a record without changing the content in the field or portion of the record.

Continuation character: Synonymous with continuation field code.

Continuation field code: Characters following the field definition characters in the program and indicate the program shift (alpha or numeric) for the remaining positions in the program.

Control statement: Synonymous with mask statement.

Copy: The duplication of data from one disk onto another disk.

Counters: Devices that count keystrokes, records, and corrections (made while verifying). These counters are used for production statistics.

Current field: The field being processed by the operator.

Cursor: The underscore character (`_`) on the display screen that indicates where the next character will be entered (referred to as cursor position).

Data: Information that is keyed from a source document.

Data set: The various types of information related to a particular job and entered as a group of records.

Data set label: The information in track 00 (index track) that identifies a particular data set.

Disk: The magnetic media on which data is recorded.

Disk error: An error condition caused by the disk or machine. Disk error numbers are 1, 2, 3, 4, 5, 7.

Diskette: The square plastic container and its enclosed disk.

Duplicate fields: Fields programmed to repeat information from the same field in the previous record.

End programming code: Synonymous with end-of-program character.

End-of-program character: The letter (E) used to make the end of the program.

EOD (end of data): The address of the next available sector on the disk for a record. This address is in positions 75 through 79 of a data set label on the index track.

Error code: A character displayed in the status line to indicate type of error occurring.

Field: A specific number of character positions reserved by means of a program for a particular category of data for a record(s). For example, the positions in which the cost of a part is entered.

Field definition character: The letter used in a program to mark the beginning of a data field. The letter also defines the shift and the type of field, such as R for a right adjust field, S for a skip field, etc.

Fill character: Either a blank or zero. Used in right adjust fields, from the first position to the first non-fill character entered in the field.

Index track: The first track on the disk (track 00).

Load: To enter a program into a storage area.

Machine mode: Pertains to what the machine is set up to do (that is enter, verify) and is indicated in the status line.

Machine status: Refers to the code in the status line that tells you whether the machine is ready (R) or not ready (N) or requires you to wait (W).

Manual fields: Any field that the machine does not automatically process.

Mask statement: A set of instructions stored in the program area of the machine when doing field totals operations.

Numeric shift: The top character on each key (except A and Z).

Offline: An operation done with a previously keyed job when doing a field totals operation.

Pointer: Identifies the position in a buffer that data is being moved from or placed into, during a card read or punch operation.

Program: A set of instructions that tell the machine what to do with data as you key it.

Program chaining: A method used for automatic program selection.

Program code: The characters that make up a program.

Program field: A field containing program code characters to specify the type of field, program shift, and length of the field.

Program number: The number in the status line that gives the storage area number of the program currently being used.

Program shift code: The letter in the status line that indicates the program shift (alpha or numeric) of the character to be keyed.

Record: A piece of data no more than 128 characters long that is usually only part of a related set of data.

Record address: The track and sector number of a record.

Right adjust: To enter characters at the right end of a field.

Sector: A section in a track on the disk for a record.

Skip field: A field in which data is blanked.

Source document: Material containing the information to be keyed.

Status line: The top line on the display screen. Gives information such as cursor position, record address, and machine mode.

Verify bypass field: A field that is bypassed during verify mode but not during enter or update mode.

Verify indicator field: A single character field indicating whether or not a data set is verified. The field contains a V if verified; it contains a blank if not verified.

Verify mark: Synonymous with verify indicator field.

Index

- accessibility error 8
- accessibility field 8, 10
- accumulate totals fields 37, 41
- accumulator display, field totals 36, 40
- accumulators
 - description 37, 41
 - field totals 37, 41
- ACL program execution, unattended 66
- adapter, I/O (see I/O adapter)
- adding records
 - description 22
 - operating procedures 22
 - record insertion 20
 - to a batch 22
- adjustable forms tractor 96
- adjustable margins feature 95
- alternate record advance 12
- AND function 43, 45
- auto balance example 39
- automatic continuation of printing 98
- auxiliary duplication
 - description 28
 - in verify 14
- available features 4

- bad spot
 - description 23
 - handling of 23, 24
- bad track
 - check 53
 - code, writing 51
 - error 53
 - identification 53
 - specification error 54
- batch auditing 36, 40
- begin field codes (see field definition characters)
- beginning of extent field 8, 9, 72
- bid response error, negative 90
- bidirectional printing 96
- binary synchronous communications (see BSC)
- BOE field 8, 9, 72
- BSC (binary synchronous communications)
(see also communications; teleprocessing)
 - CE status line 86, 88, 92
 - data set label fields
 - beginning of extent 72
 - end of data 72, 73
 - end of extent 72, 73
 - multivolume indicator 73
 - disk errors 90
 - electrical circuits 61
 - BSC (binary synchronous communications) (continued)
 - error conditions 89
 - error recovery 92
 - example
 - receive 74
 - transmit 71
 - transmit/receive 77
 - facilities 57
 - features 61
 - indicators
 - sectors 91
 - status 88
 - track 91
 - modes 68
 - operating procedures 82
 - programming support 68
 - status message
 - description 92
 - format 92
 - summary 81
 - throughput 94
- BSC CE status line 88, 92
- BSCA
 - disk(s) full error 90
 - modes 88
 - received data block check 91
 - setup error 90
- buffers
 - current record 5
 - definition 5
 - expanded 63
 - hold 5
 - input 123
 - output 123
 - previous 5
 - program 5
- bypass data set field 8, 10
- bypass field definition code 26, 27

- card punch to hex conversion 136
- card read/punch format control
 - automatic selection 120
 - manual selection 120
 - program level A 120
 - program level 9 120
 - programs 121
- card read/punch format control characters 121
- card read/punch format control examples 124
- card read/punch format instruction set 121
- card reader feature, operator identification 62
- carrier, common (see common carrier)

CE mode 24
 CE status line, BSC 92
 chaining characters 30
 chaining, program 30
 changing a program in a program buffer 30
 channel errors, system 134
 character codes 26
 character keys 2
 character sets, 3717 97
 characters, control statements 43
 characters, edit 111
 checking a disk 53
 circuits, teleprocessing 61
 clock feature, synchronous 61
 codes, alert and error 89, 90
 coding a program 25
 collating sequence 18
 COMM key 70, 72
 common carrier
 nonswitched 59
 switched 60
 communications
 (see also BSC; teleprocessing)
 configurations 58
 description 57
 example
 receive 74
 transmit 71
 transmit/receive 77
 facilities 57
 modes 68
 multipoint 67
 compare remote terminal identification sequence 62
 computing self-check digit
 modulus 10 55
 modulus 11 56
 content search, search mode 17
 continuation characters
 alpha 26, 27
 field 25
 numeric 26, 27
 continue field codes (see continuation characters)
 continued control statements, field totals 44
 continuous card read mode 118
 control characters
 data recorder 121
 printer format 100
 control statement characters, offline field totals 43
 control statement format character description 43
 character present or absent 44
 comma 44
 compare character 44
 continued control statement 44
 end of last statement 44
 less than sign 43
 logical AND 45
 program buffer to be selected 43
 statement separator 44
 three digit position number 43
 control statements 42
 conversion table, track to record 35
 copy
 all (image copy) or part of a data set 50
 all (image copy) or part of disk 2 50
 copying a record 50
 handling disk errors 23
 up to a specified record on disk 2 50
 COPY key 49
 copying a record 50
 correction keystroke counter, verify 34
 counters display 34
 counters, production statistics 34
 creating and storing programs 28
 creation date field 9, 10
 cross footing 36
 current record buffer 5
 current record buffer, format 119

 DASH key 12, 14, 15
 data block error, BSCA received 90
 data call termination 89
 data converter 8, 9, 10
 DATA DISPLAY key 30
 data entry system overview 1
 data field, sector 6, 51
 data information lines 2
 data recorder attachment feature 117
 data recovery
 description 22
 methods 22
 data set empty error 13
 data set label error checking 11
 data set label fields
 accessibility 8, 10
 beginning of extent 8, 9
 BSC (see BSC data set label fields)
 bypass data set 8, 10
 creation date 9, 10
 data set name 8, 9
 description 8
 end of data 9, 10
 end of extent 8, 10
 error checking 11
 expiration date 9, 10
 header 1 8, 9
 interchange type 9, 10
 location 7, 9, 10
 modification 11
 multivolume indicator 9, 10
 record length 8, 9
 summary 9, 10
 verify indicator 9, 10
 volume sequence number 9, 10
 write protect 8, 10
 data set label updated, continuous card read 119
 data set labels
 description 8
 error 11
 index track 7

- data set mode, printer 97
- data set name field 8, 9
- data set not ready error 90
- data station 1
- data stream printer control characters 107
- data tracks 7
- definition characters, field 26
- DELETE REC key 19
- deleted record error 17, 19
- deleted records
 - description 19, 20
 - enter mode 20
 - search mode 20
 - sector content 20
 - update mode 20
 - verify mode 20
- delimiter character, prompting record 32
- digit, self-check 55
- disk checking 53
- disk error handling when copying, recovery 24
- disk errors
 - BSCA 90
 - disk read 23
 - disk write 24
 - initialization 52
 - I/O adapter 134
 - no record found 23
 - seek 23
- disk initialization
 - disk checking 53
 - errors 54
 - procedure 52
 - purpose 51
 - record sequence 52
- disk layout 7
- disk not accessible error 8
- disk read error 23
- disk record sequences 52
- disk write error 24
- disk 2
 - copy (see copy)
 - not ready error 90
 - operation 49
 - preparation 49
 - search operations 49
- DISK 2 REC ADV key 49
- DISK 2 REC BKSP key 49
- DISK 2 RETURN TO INDEX key 49
- disk(s) full error, BSCA 90
- diskette
 - care 3
 - description 3
 - handling 3
 - layout 7
 - storage 3
- DISPLAY DATA key 30
- DISPLAY FIELD NAME key 33
- DISPLAY FIELD PROG key 33
- display lines 2
- DISPLAY PROD STAT key 35
- DISPLAY PROG key 30
- display screen 2
- display, verify mode 14
- displaying
 - a program 30
 - field totals 36, 40
 - hexadecimal data 19
 - offline field total accumulators 40
 - production statistics 34
- dual disk
 - (see also disk 2)
 - capability 49
 - copy (see copy)
 - operation 49
 - preparation 49
 - search operation 49
- duplicate fields 26, 27
- duplicate program field 26, 27
- duplication functions
 - auxiliary 28
 - description 27, 28
 - verify mode 14
- editing
 - characters 111
 - consideration 111
 - description 111
 - example 114
 - 3715 printer 111
 - 3717 printer 111
- electrical circuits, teleprocessing 61
- empty data set error 13
- end of data field 9, 10, 73
- end of data dearch, search mode 16
- end of extent
 - error 13, 15
 - field 8, 10, 73
- end of file card 119
- end of job card 118
- end of last statement, field totals 44
- end-of-program character 25
- end programming code (see end-of-program character)
- engraved character font 97
- ENTER key 12
- enter mode
 - alternate record advance 12
 - data flow 12
 - description 12
 - negative value 12
 - right field-adjust fields considerations 12
- EOD field 9, 10, 73
- EOD SEARCH key 16
- EOE error 13, 15
- EOE field 8, 10, 73
- error codes, disk initialization 54
- error conditions, BSC 89
- error conditions, printer 110
- error correction, verify mode 14
- error handling when copying, recovery 22
- error recovery, self-check errors 55

- errors, disk initialization 54
- example
 - chaining 31
 - communications 71, 77
 - data recorder formatting 124
 - edit 113
 - offline field totals 45, 47
 - operator guidance 31
 - receive mode 74
- expanded buffer 63
- expanded communications feature 63
- expanded communications program control 66
- expanded communications receive 72
- expanded communications transmit mode 69
- expanded communications transmit/receive mode 76
- expanded communications/multipoint data link control feature 66
- expiration date 9, 10

- features
 - available 4, 61
 - BSC 61
 - data recorder 117
 - data station 1
 - printer 95
 - proof keyboard 116
- field continuation character 25, 26
- FIELD COR key 15
- field correct mode 15
- field definition characters 25
- FIELD NAME DISPLAY key 33
- FIELD PROG DISPLAY key 33
- field totals
 - description 18
 - display 36, 40
 - mode 18
 - offline 18, 40
 - online 18, 36
 - operations 46
- fields
 - accessibility 8, 10
 - accumulate totals 37, 41
 - beginning of extent 8, 9
 - bypass data set 8, 10
 - creation date 9, 10
 - data set label for BSC (see BSC data set label fields)
 - data set name 8, 9
 - description
 - data set label 8
 - offline field totals 40
 - online field totals 36
 - program 25
 - duplicate 26, 27
 - end of data 9, 10
 - end of extent 8, 10
 - expiration date 9, 10
 - field continuation 25, 26
 - header 1 8, 9
 - interchange type 9, 10
 - manual alphabetic 26, 27
 - fields (continued)
 - manual numeric 26, 27
 - multivolume indicator 9, 10
 - read out 41
 - read out/reset 37, 41
 - record length 8, 9
 - right adjust 26, 27
 - self-check 26, 28
 - skip 26, 28
 - unconditional bypass 26, 27
 - verify indicator 9, 10
 - volume sequence number 9, 10
 - write protect 8, 10
 - file transfer 130
 - format control (see local format control; processing unit format control)
 - formatting
 - current record buffer 119
 - data recorder 120
 - printer 98
 - forms stand feature 95
 - function error 11
 - function keys 2
 - function switches, data recorders 122
 - functions
 - BSC 57
 - data station 4
 - printer 97

 - half duplex mode 57
 - handling disk errors when copying, recovery 23, 24
 - handling of bad spots 23, 24
 - hardware, printer
 - description 95
 - features 95
 - hash totals 36, 40
 - header 1 field 8, 9
 - HEX key 19
 - hexadecimal data
 - description 18, 19
 - displaying 19
 - multipunch 19
 - negative value 19
 - verify 15
 - hexadecimal display 19
 - hold buffer 5
 - horizontal tab 102
 - how format control works 123

 - IBM diskette (see diskette)
 - IBM 129 card data recorder 117
 - IBM 3540 diskette input/output unit 8
 - IBM 3713 printer (see 3713 printer)
 - IBM 3715 printer (see 3715 printer)
 - IBM 3717 printer (see 3717 printer)
 - IBM 3741 data station (see 3741 data station)

- IBM 3747 data converter 8, 9, 10
- IBM 5496 data recorder 117
- ICA (integrated communications adapter) 68
- identification card reader feature, operator 62
- identification feature, terminal
 - description 61
 - remote terminal identification compare 62
 - transmitting terminal identification sequence 61
- identification field
 - sector 51
 - writing 51
- identification sequence compare, remote terminal 62
- identification sequence, terminal 61
- incorrect label error 11
- index track
 - data set labels 8
 - description 8
 - layout 7
- index track layout 7
- indicator field, multivolume 9, 10
- indicator, BSC
 - sector 91
 - track 91
- indicators, BSC error 89
- initialization errors 54
- initialization procedure 52
- initialization, disk (see disk initialization)
- input buffer 123
- input specification error 54
- inquiry 67
- inquiry mode
 - description 80
 - termination 89
- inquiry operating procedure 87
- insert constants, receive data and 65
- inserting records 20
- instruction set, data recorder 121
- instruction set, printer 99, 107
 - local format control 99
 - processing unit format control 107
- integrated communications adapter 68
- interchange type indicator field 9, 10
- I/O adapter 130
 - error recovery procedure 134
 - file transfer 130
 - mode summary 133
 - mode 1-5 131
 - system channel errors 134
- keyboard 2
- keyboard, proof 116
- keylock feature 62
- keystroke counter 34
- label modification 11
- label, incorrect 11
- less than sign, field totals 43
- line bid error 89
- line check error 89
- line termination 89
- loading a program 25
- local format control
 - advantages 99
 - description 99
 - example 104
- logical AND function 43, 45
- manual alphabetic fields 26, 27
- manual numeric fields 26, 27
- margins feature, adjustable 95
- mask, during search 17
- matrix printer 95
- merge records 49
- message aborted error 89
- message, BSC status
 - description 92
 - format 92
- missing data 22
- mode of operation
 - BSC
 - receive 72
 - transmit 69
 - transmit/receive 73
 - definition 6
 - enter 12
 - field correct 15
 - field totals 18
 - general 6
 - modify 11
 - printer 97
 - read index 6
 - search 15
 - update 13
 - verify 13
- mode selection error
 - enter 12
 - field correct 15
 - modify 11
 - search on content 17
 - search on record address 16
 - search to end of data 16
- modem 61
- modify mode 11
- modifying a label 11
- modifying a program 25, 30
- modulus 10 55
- modulus 11 56
- multiple data sets created 119
- multiple data sets per disk 11
- multiple network audible alarm 91
- multipoint communications 67
- multipunch operations 19
- multivolume indicator field 9, 10, 73

- negative bid response error 90
- negative value 12, 19
- networks
 - nonswitched 57, 59
 - switched 57, 60
- no record found error 23
- nonswitched multipoint communications 66, 67
- nonswitched network 59
- not ready error, data set 90
- numeric continuation characters 25, 26

- offline field totals
 - control statement 42
 - description 40
 - display 40
 - examples 45
 - operation 40
 - programming 41
 - selection 40
 - setup example 47
 - unconditional program selection 46
 - writing on disk 41
- offline field totals fields
 - accumulate totals 41
 - read out 41
 - read out/reset 41
- online field totals
 - description 36
 - example 38
 - operation 36
 - programming 36
 - restrictions 38
- operating procedures, BSC 82
- operator guidance
 - description 31
 - example 33
- operator identification card reader feature 62
- operator interface
 - display 2
 - keyboard 2
- operator initiated termination 90
- output buffer 123

- pin-feed platens 95
- platens, pin-feed 95
- point-to-point networks 57, 59
- pooling data 49
- power on
 - buffer content 5
 - description 5
 - errors 5
 - status line content 5
- preparation of dual disk on 3741 49
- previous record buffer 5
- print data set mode 97
- print record mode 97
- print under search address mode 98
- print under search content mode 98

- printer
 - (see also 3713 printer, 3715 printer, or 3717 printer)
 - control characters, data stream 107
 - detailed description 95
 - editing 111
 - error conditions 110
 - format control characters 100
 - format program selection 102
 - formatting 98
 - functions 97
 - instruction set 99, 107
 - local format control 99
 - processing unit format control 107
 - modes 97
 - printing, unattended 65
 - private line channels 59
 - processing unit format control
 - advantages 99
 - description 107
 - PROD STAT DISPLAY key 35
 - production statistics
 - description 34
 - displaying 34
 - keystroke counter 34
 - record counter 34
 - verify correction keystroke counter 34
 - writing on disk 35
 - program
 - chaining 30
 - chaining in a program buffer 30
 - changing a program in a program buffer 30
 - coding 25
 - control, expanded communications 66
 - creating 25, 28
 - description 25
 - displaying 30
 - end of program character 25
 - fields description 25
 - modification 25, 30
 - selection, printer format 98, 102
 - storing 25
 - summary chart 26
 - program buffer A 99, 102, 120, 131
 - program buffer to be selected, field totals 43
 - program buffer 0 25
 - program buffer 9 120
 - program chaining
 - characters 30
 - description 30
 - example 31
 - program continuation character 25, 26
 - program field definition character 25
 - program field descriptions
 - duplicate 26, 27
 - field continuation 25, 26
 - manual alphabetic 26, 27
 - manual numeric 26, 27
 - right adjust 26, 27
 - self-check 26, 28
 - skip 26, 28
 - uncondition bypass 26, 27

- program storage area (see program buffer)
- programmable work station 1
- programming information 25
- programming offline field total fields 41
- programming online field total fields 36
- programming support for teleprocessing 68
- prompting messages 32
 - loading 32
 - writing 32
- prompting records 32
- proof keyboard feature 116
- punch modes
 - punch data set 117
 - punch record 117
 - punch under search address 118
 - punch under search content 118
- punch operations
 - cancel 117
 - description 117

- read error 23
- read index mode
 - data flow 6
 - description 6
- read modes
 - continuous card read 118
 - read a card 118
- read operations
 - cancel 118
 - description 118
- read out field totals fields 41
- read out/reset field totals fields 37, 41
- reader feature, operator identification card 62
- REC ADV key, DISK 2 49
- REC BKSP key, DISK 2 49
- receive data and insert constants 65
- receive mode example 74
- receive mode/expanded communications receive 72
- receive/transmit mode 74
- receive/transmit-transparent mode 76
- receive data block error, BSCA 91
- received line bid error 89
- record address search, search mode 16
- record advance, alternate function 12
- record advance, verify mode 15
- record copying 50
- record counter 34
- record insert feature 20
- record insert mode characteristics
 - enter mode 21
 - read index mode 21
 - search mode 21
 - update mode 21
 - verify mode 21
- record insertion 20
- record length
 - description 8, 72
 - field 8, 9

- record merge 49
- record mode, printer 97
- recovery procedures 22
- reinitialization requirements 51
- remote abort error 89
- reset/read out fields 37, 41
- restrictions, online field totals 38
- RETURN TO INDEX key, DISK 2 49
- RIGHT ADJ key 12, 14
- right adjust error 14, 15
- right adjust fields 14, 27
- right adjust fields, enter mode 12
- right adjust fields, verify mode 14
- right adjust sign error 14, 15

- search address error 16
- search address mode, print under 98
- SEARCH CONTENT key 17
- search content mode, print under 98
- search error 17
- search mask 17
- search mode
 - canceling 16
 - data flow 16
 - description 15
 - search on content 17
 - search on record address 16
 - search on sequential content 17
 - search to end of data 16
 - selection 16, 17
- search on content, search mode 17
- search on record address, search mode 16
- search on sequential content, search mode 17
- search operations, dual disk 49
- SEARCH SEQ CONTENT key 17
- second disk
 - advantages 49
 - copy (see copy)
 - operation 49
 - preparation on 3741 49
 - search operations 49
- sector not deleted error 54
- sectors
 - contents 7
 - data field 7
 - definition 7
 - identification field 51
 - indicators 91
 - sequence code 51, 52
- seek error 23
- self-check digit
 - computing
 - modulus 10 55
 - modulus 11 56
 - description 55
- self-check error 55

- self-check feature
 - computing self-check digit 55
 - description 55
 - error recovery 55
- self-check fields 26, 28, 55
- SEQ CONTENT SEARCH key 17
- sequence code, sector 51, 52
- sequence compare, remote terminal identification 62
- sequence, terminal identification 61
- sequential content search, search mode 17
- setup error, BSCA 90
- sign error, right adjust 14
- signs, verify mode 15
- skip fields 26, 28
- skip functions, verify mode 14
- standard functions 4
- starting information 5
- statement separator, field totals 44
- statement, mask 17
- stations, status line 2
- statistics, production
 - description 34
 - display 34
 - keystroke counter 34
 - record counter 34
 - verify correction keystroke counter 34
 - writing on disk 3
- status indicators 88
- status line 2
- status message format 92
- storing programs 25, 28
- switched network 60
- switches, function 122
- synchronous clock feature 61
- system channel errors 134
- system overview 1

- tab characters 102
- teleprocessing
 - (see also BSC; communications)
 - description 57
 - electrical circuits 61
 - facilities 57
 - features 57
 - programming support 68
- terminal identification
 - compare, remote 62
 - feature
 - description 61
 - remote terminal, identification compare 62
 - transmitting terminal identification sequence 61
 - sequence 61
- termination
 - data call 89
 - inquiry mode 89
 - line 89
 - operator initiated 90
- three digit position number, field totals 43
- throughput
 - communications 94
 - 129 card data recorder 117
 - 3713 printer 95
 - 3715 printer 96
 - 3717 printer 97
 - 5496 data recorder 117
 - timings
 - (see also throughput communications)
 - search, copy, initialization communication BSC 135
 - totals
 - display 36, 40
 - field (see field totals)
 - offline 40
 - online 36
 - track check 53
 - track indicators 78, 91
 - track specification error 54
 - track to record conversion 35
 - tracks error 53, 54
 - transmission modes
 - disk 1 68
 - disk 2 68
 - transmit mode 69
 - transmit mode, expanded communications 69
 - transmit selected fields 63
 - transmit selected records 63
 - transmit terminal identification sequence 61
 - transmit/receive mode 74
 - transmit/receive mode, expanded communications 76
 - transmit-transparent mode 70
 - transmit-transparent/receive mode 76
 - transparency check error 89
 - transparent-transmit mode 70
 - transparent-transmit/receive mode 76
 - truncation error 25
- U error 110
- unattended ACL program execution 66
- unattended print setup error 91
- unattended printing 65
- unconditional bypass fields 26, 27
- unconditional program selection, offline field totals 46
- UPDATE key 13
- update mode
 - data flow 13
 - description 13
 - selection 13
- uses, printer 95
- verification code, verify mode 15
- verify correction keystroke counter 34
- verify indicator field 9, 10
- VERIFY key 13
- verify mark (see verify indicator field)

- verify mismatch error 13, 14
- verify mode
 - data flow 13
 - description 13, 14
 - display 14
 - duplication functions 14
 - error correction 14
 - hexadecimal data 15
 - record advance 15
 - right adjust fields 14
 - selection 13
 - signs 15
 - skip functions 14
 - verification code 15
- vertical forms control 102
- vertical skip stop characters 102, 103
- volume identification 7
- volume label description 7
- volume sequence number field 9, 10

- W error 110
- write error 24, 54
- write protect BSC considerations 70
- write protect error 13, 91
- write protect field 8, 10
- writing field totals on disk 37, 41
- writing over data, BSC 76
- wrong length check error 90

- 129 card data recorder 117
- 3713 printer
 - (see also printer)
 - description 95
 - features 95
 - uses 95
- 3715 printer
 - (see also printer)
 - description 96
 - editing 111
 - features 96
 - uses 96
- 3717 printer
 - (see also printer)
 - character sets 97
 - description 97
 - editing 111
 - features 97
 - uses 97
- 3540 diskette input/output unit 8
- 3741 data station
 - description 1
 - display 2
 - keyboard 2
 - overview 1
- 3747 data converter 8, 9, 10
- 5496 data recorder 117

READER'S COMMENT FORM

Please use this form only to identify publication errors or request changes to publications. Technical questions about IBM systems, changes in IBM programming support, requests for additional publications, etc, should be directed to your IBM representative or to the IBM branch office nearest your location.

Error in publication (typographical, illustration, and so on). **No reply.**

Page Number *Error*

Inaccurate or misleading information in this publication. Please tell us about it by using this postage-paid form. We will correct or clarify the publication, or tell you why a change is not being made, provided you include your name and address.

Page Number *Comment*

Note: All comments and suggestions become the property of IBM.

Name _____

Address _____

● No postage necessary if mailed in the U.S.A.



International Business Machines Corporation

**General Systems Division
4111 Northside Parkway N.W.
P.O. Box 2150
Atlanta, Georgia 30301
(U.S.A. only)**

**General Business Group/International
44 South Broadway
White Plains, New York 10601
U.S.A.
(International)**

READER'S COMMENT FORM

Please use this form only to identify publication errors or request changes to publications. Technical questions about IBM systems, changes in IBM programming support, requests for additional publications, etc. should be directed to your IBM representative or to the IBM branch office nearest your location.

Error in publication (typographical, illustration, and so on). **No reply.**

Page Number *Error*

Inaccurate or misleading information in this publication. Please tell us about it by using this postage-paid form. We will correct or clarify the publication, or tell you why a change is not being made, provided you include your name and address.

Page Number *Comment*

Note: All comments and suggestions become the property of IBM.

● No postage necessary if mailed in the U.S.A.

Name _____
Address _____

Cut Along Line

Fold

Fold



NO POSTAGE
NECESSARY
IF MAILED
IN THE
UNITED STATES

BUSINESS REPLY MAIL

FIRST CLASS PERMIT NO. 40 ARMONK, N.Y.

POSTAGE WILL BE PAID BY ADDRESSEE:

IBM Corporation
General Systems Division
Development Laboratory
Publications, Dept. 245
Rochester, Minnesota 55901

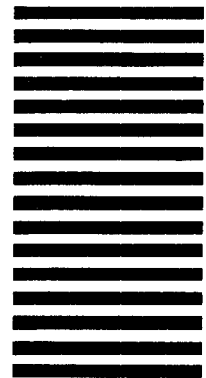

IBM 3741 Data Station Reference Manual Printed in U.S.A. GA21-9183-4

Fold

Fold



International Business Machines Corporation

**General Systems Division
4111 Northside Parkway N.W.
P.O. Box 2150
Atlanta, Georgia 30301
(U.S.A. only)**

**General Business Group/International
44 South Broadway
White Plains, New York 10601
U.S.A.
(International)**

Cut Along Line

Fold

Fold



NO POSTAGE
NECESSARY
IF MAILED
IN THE
UNITED STATES

BUSINESS REPLY MAIL
FIRST CLASS PERMIT NO. 40 ARMONK, N.Y.

POSTAGE WILL BE PAID BY ADDRESSEE:

IBM Corporation
General Systems Division
Development Laboratory
Publications, Dept. 245
Rochester, Minnesota 55901

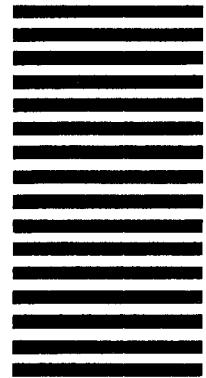

IBM 3741 Data Station Reference Manual Printed in U.S.A. GA21-9183-4

Fold

Fold



International Business Machines Corporation

General Systems Division
4111 Northside Parkway N.W.
P.O. Box 2150
Atlanta, Georgia 30301
(U.S.A. only)

General Business Group/International
44 South Broadway
White Plains, New York 10601
U.S.A.
(International)